

Video Cassette Recorder

Operating Instructions



SLV-SE830G

Hi-Fi

SLV-SE730G//

Hi-Fi

SLV-SE230G//



WARNING

To prevent fire or shock hazard, do not expose the unit to rain or moisture.

To avoid electrical shock, do not open the cabinet. Refer servicing to qualified personnel only.

Mains lead must only be changed at a qualified service shop.

Notice for customers in the United Kingdom and Republic of Ireland

A moulded plug complying with BS1363 is fitted to this equipment for your safety and convenience. Should the fuse in the plug supplied need to be replaced, a 5 AMP fuse approved by ASTA or BSI to BS1362, (i.e., marked with  or  mark) must be used.

If the plug supplied with this equipment has a detachable fuse cover, be sure to attach the fuse cover after you change the fuse. Never use the plug without the fuse cover. If you should lose the fuse cover, please contact your nearest Sony service station.

Precautions

Safety

- This unit operates on 220 – 240 V AC, 50 Hz. Check that the unit's operating voltage is identical with your local power supply.
- If anything falls into the cabinet, unplug the unit and have it checked by qualified personnel before operating it any further.
- The unit is not disconnected from the mains as long as it is connected to the mains, even if the unit itself has been turned off.
- Unplug the unit from the wall outlet if you do not intend to use it for an extended period of time. To disconnect the cord, pull it out by the plug, never by the cord.
- To prevent fire or shock hazard, do not place objects filled with liquids, such as vases, on the apparatus.

Installing

- Do not install this equipment in a confined space such as a book or similar unit.
- Allow adequate air circulation to prevent internal heat buildup.
- Do not place the unit on surfaces (rugs, blankets, etc.) or near materials (curtains, draperies) that may block the ventilation slots.
- Do not install the unit near heat sources such as radiators or air ducts, or in a place subject to direct sunlight, excessive dust, mechanical vibration or shock.
- Do not install the unit in an inclined position. It is designed to be operated in a horizontal position only.
- Keep the unit and cassettes away from equipment with strong magnets, such as microwave ovens or large loudspeakers.

- Do not place heavy objects on the unit.
- If the unit is brought directly from a cold to a warm location, moisture may condense inside the VCR and cause damage to the video head and tape. When you first install the unit, or when you move it from a cold to a warm location, wait for about three hours before operating the unit.

Caution

Television programmes, films, video tapes and other materials may be copyrighted. Unauthorized recording of such material may be contrary to the provisions of the copyright laws. Also, use of this recorder with cable television transmission may require authorization from the cable television transmitter and/or programme owner.

Compatible colour systems

This VCR is designed to record and play back using the PAL colour system. Recording of video sources based on other colour systems cannot be guaranteed.

VIDEO Plus+ and PlusCode are registered trademarks of Gemstar Development Corporation. The VIDEO Plus+ system is manufactured under license from Gemstar Development Corporation.

Table of contents

Getting Started

- 4 Index to parts and controls
- 11 Step 1 : Unpacking
- 12 Step 2 : Setting up the remote commander
- 16 Step 3 : Connecting the VCR
- 20 Step 4 : Setting up the VCR with the Auto Set Up function
- 22 Downloading the TV tuner's preset data (not available on SLV-SE230G/I)
- 23 Selecting a language
- 24 Presetting channels
- 27 Changing/disabling programme positions
- 32 Setting the clock

Basic Operations

- 34 Playing a tape
- 36 Recording TV programmes
- 40 Recording TV programmes using the Dial Timer (SLV-SE830G only)
- 45 Recording TV programmes using the VIDEO Plus+® system
- 49 Setting the timer manually

Additional Operations

- 52 Playing/searching at various speeds
- 54 Setting the recording duration time
- 55 Checking/changing/cancelling timer settings
- 57 Recording stereo and bilingual programmes (not available on SLV-SE230G/I)
- 59 Searching using the index function (not available on SLV-SE230G/I)
- 61 Adjusting the picture
- 62 Reducing the VCR's power consumption
- 63 Changing menu options

Editing

- 65 Connecting to a VCR or stereo system
- 67 Basic editing
- 68 Audio dubbing (SLV-SE830G only)

Additional Information

- 69 Troubleshooting
- 73 Specifications
- 74 Index

Back Cover

Quick Start Guide

Index to parts and controls

Refer to the pages indicated in parentheses () for details.

Front panel

For SLV-SE830G

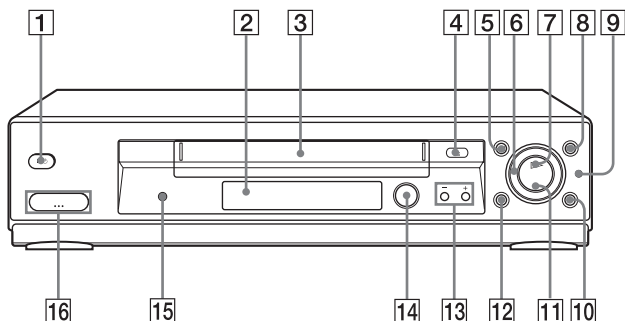

- | | |
|--|--|
| <p>1 I/⏻ (on/standby) switch</p> <p>2 Remote sensor (12)</p> <p>3 Tape compartment</p> <p>4 ⏏ (eject) button (34)</p> <p>5 ◀◀ (rewind) button (34) (52)</p> <p>6 Shuttle ring (52)</p> <p>7 ▷ (play) button* (34) (52)</p> <p>8 ▶▶ (fast-forward) button (34) (52)</p> <p>9 JOG button (52)</p> <p>10 REC ● (record) button (37) (54) (67)</p> <p>11 ■ (stop) button* (21) (34) (67) (68)</p> | <p>12 ■■ (pause) button (34) (44) (67) (68)</p> <p>13 PROGRAM +/- buttons* (41) (53) (61)</p> <p>14 ⌚ DIAL TIMER (40)</p> <p>15 AUDIO DUB button (68)</p> <p>16 ↶ LINE-2 L (left) ↷ R (right) jacks (covered)* (65) (66) (68)</p> |
|--|--|

How to open the jack cover

- 1 Press the bottom of the cover.
- 2 Hook your finger on the top edge of the cover and pull it open.

* The ▷ (play), ■ (stop) and PROGRAM + buttons and jack cover have a tactile dot.

For SLV-SE730G/I

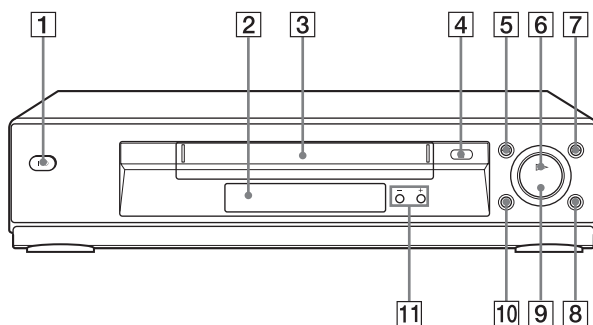

1 I/⏻ (on/standby) switch

2 Remote sensor (12)

3 Tape compartment

4 ≡ (eject) button (34)

5 ◀◀ (rewind) button (34) (52)

6 ▷ (play) button* (34) (52)

7 ▶▶ (fast-forward) button (34) (52)

8 REC ● (record) button (37) (54) (67)

9 ■ (stop) button* (21) (34) (67) (68)

10 || (pause) button (34) (67) (68)

11 PROGRAM +/- buttons* (53) (61)

* The ▷ (play), ■ (stop) and PROGRAM + buttons have a tactile dot.

continued

For SLV-SE230G/I

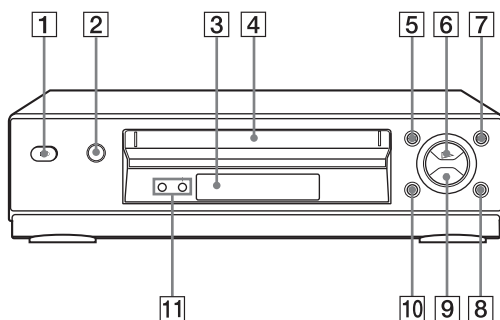

1 I/O (on/standby) switch

2 ≡ (eject) button (34)

3 Remote sensor (12)

4 Tape compartment

5 ◀◀ (rewind) button (34) (52)

6 ▷ (play) button* (34) (52)

7 ▶▶ (fast-forward) button (34) (52)

8 REC ● (record) button (37) (54) (67)

9 ■ (stop) button* (21) (34) (67) (68)

10 || (pause) button (34) (67) (68)

11 PROGRAM +/- buttons* (53) (61)

* The ▷ (play), ■ (stop) and PROGRAM + buttons have a tactile dot.

Display window

For SLV-SE830G and SE730G/I

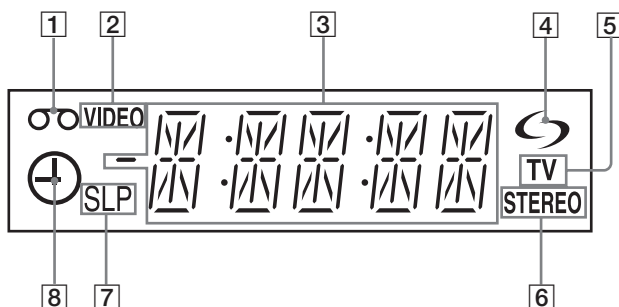

- | | |
|--|--|
| 1 Tape indicator | 5 TV indicator (39) |
| 2 VIDEO indicator (17) (37) | 6 STEREO indicator (57) |
| 3 Time counter/clock/line/programme position indicator (34) (36) (67) | 7 Tape speed indicators (36) |
| 4 ↔ (smartlink) indicator (18) | 8 Timer/recording indicator (37) (42) (47) (50) |

For SLV-SE230G/I

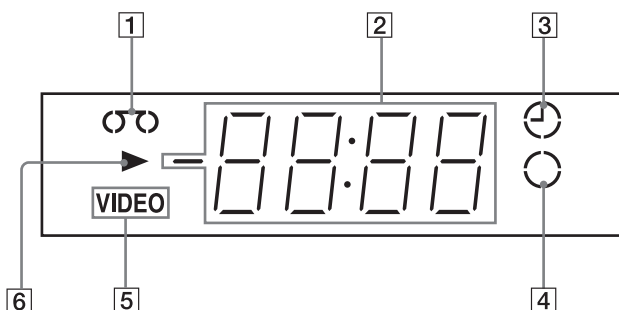

- | | |
|--|------------------------------------|
| 1 Tape indicator | 4 Recording indicator (37) |
| 2 Time counter/clock/line/programme position indicator (34) (36) (67) | 5 VIDEO indicator (17) (37) |
| 3 Timer indicator (42) (47) (50) | 6 Playback indicator |

continued

Rear panel

For SLV-SE830G and SE730G/I

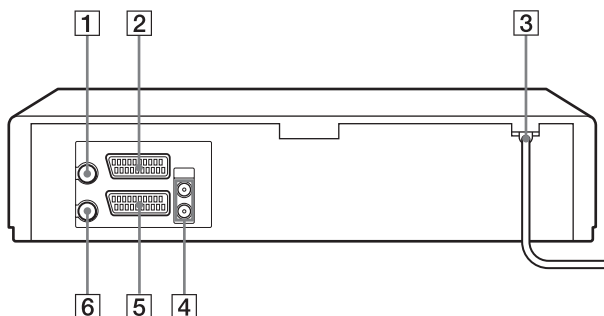

For SLV-SE230G/I

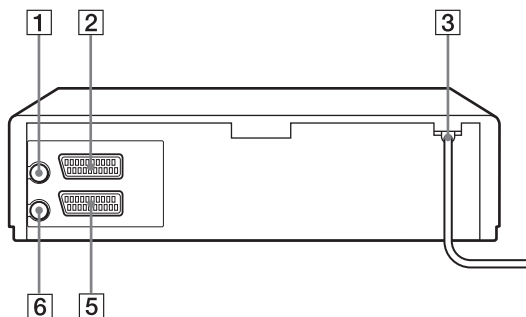

1 Π (in from antenna) connector (16) (17)

2 LINE-3 connector*¹
LINE-2 connector*² (19) (66)

3 Mains lead (16) (17)

4 AUDIO (OUT) R (right), L (left) jacks (19)

5 LINE-1 (EURO AV) connector (17) (65)

6  (out to tv) connector (16) (17)

*¹ SLV-SE830G only

*² SLV-SE730G/I and SE230G/I only

Remote commander

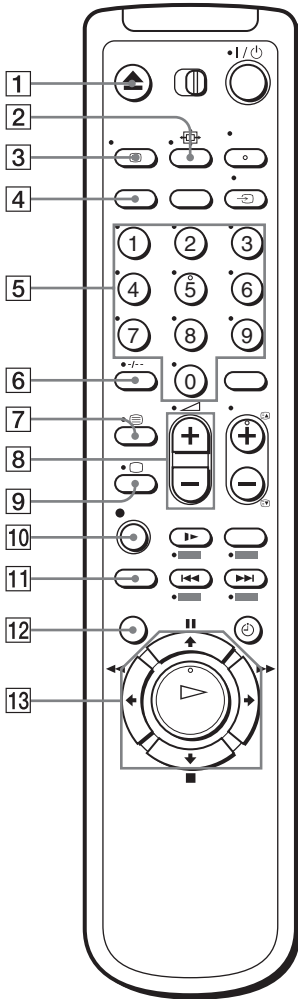

- 1 ▲ (eject) button (34)
- 2 ◀▶ (wide) button (*for TV*) (14) (15)
- 3 [D] (DISPLAY) button (14) (34) (37)
- 4 [C] (COUNTER/REMAIN) button (37)
- 5 Programme number buttons*1 (13) (38)
- 6 +/- (ten's digit) button (13) (38)
- 7 [T] (Teletext) button (*for TV*)*2 (14)
- 8 [+/−] (volume) +/- buttons (*for TV*) (13)
- 9 [□] TV power on/TV mode select button (*for TV*)*2 (13)
- 10 [●] REC (record) button (37) (54)
- 11 [S/L] (SP (Standard Play)/LP (Long Play) button (36)
- 12 [M] MENU button (32) (55)
- 13 [||] (pause)/▲ button (32) (34)
 [■] (stop)/▼ button (32) (34)
 [◀◀] (rewind)/◀ button (32) (34) (52)
 [▶▶] (fast-forward)/▶ button (32) (34) (52)
 [▷] (play)/OK button*1 (32) (34) (52)

*1 The ▷ (play), AUDIO MONITOR, number 5 and PROG + buttons have a tactile dot.

*2 SLV-SE830G only

continued

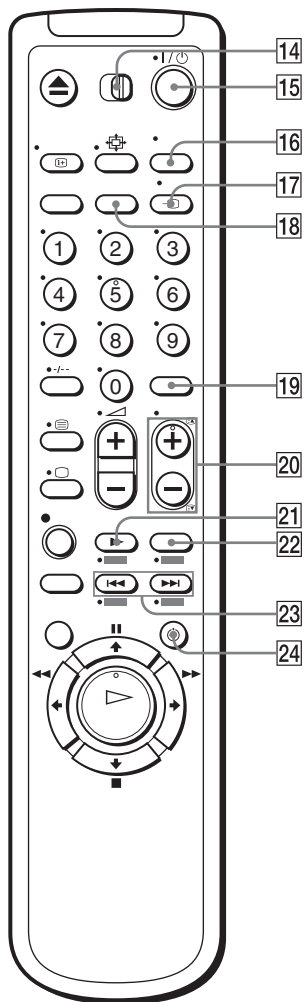

- 14** **TV / VIDEO** remote control switch (12)
- 15** **I/O** (on/standby) switch (13) (14) (47)
- 16** **AUDIO MONITOR** button*¹*³ (14) (57)
- 17** **TV/VIDEO** button (13) (17) (37)
- 18** **CLEAR** button (34) (46) (55)
- 19** **INPUT SELECT** button (36) (50) (67)
- 20** **PROG (programme) +/-** buttons*¹ (13) (36)
 - ▲** / **▼** Teletext page access buttons (for TV)*² (14)
- 21** **▶▶ SLOW** button*⁴ (52)
- 22** **x2** button*⁴ (52)
- 23** **◀◀ / ▶▶** (index search) buttons*³*⁴ (59)
- 24** **⌚** **TIMER** button (45) (49)

*¹ The **▶** (play), **AUDIO MONITOR**, number 5 and **PROG +** buttons have a tactile dot.

*² SLV-SE830G only

*³ not available on SLV-SE230G/I

*⁴ **FASTTEXT** buttons (for TV) (SLV-SE830G only)

Step 1 : Unpacking

Check that you have received the following items with the VCR:

- Remote commander

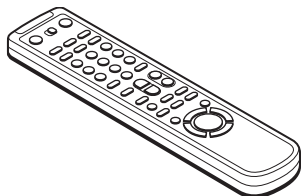

- R6 (size AA) batteries

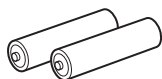

- Aerial cable

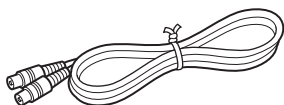

Check your model name

The instructions in this manual are for the 5 models: SLV-SE830G, SE730G, SE730I, SE230G and SE230I. Check your model name by looking at the rear panel of your VCR.

SLV-SE830G is the model used for illustration purposes. Any difference in operation is clearly indicated in the text, for example, “SLV-SE830G only.”

Step 2 : Setting up the remote commander

Inserting the batteries

Insert two R6 (size AA) batteries by matching the + and – on the batteries to the diagram inside the battery compartment.

Insert the negative (–) end first, then push in and down until the positive (+) end clicks into the position.

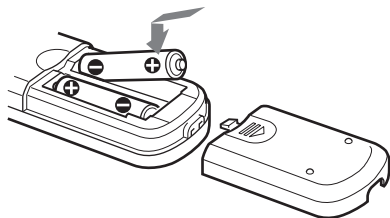

Using the remote commander

You can use this remote commander to operate this VCR and a Sony TV. Buttons on the remote commander marked with a dot (•) can be used to operate your Sony TV. If the TV does not have the  symbol near the remote sensor, this remote commander will not operate the TV.

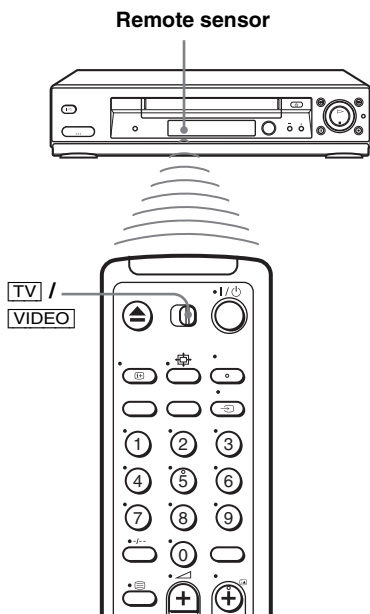



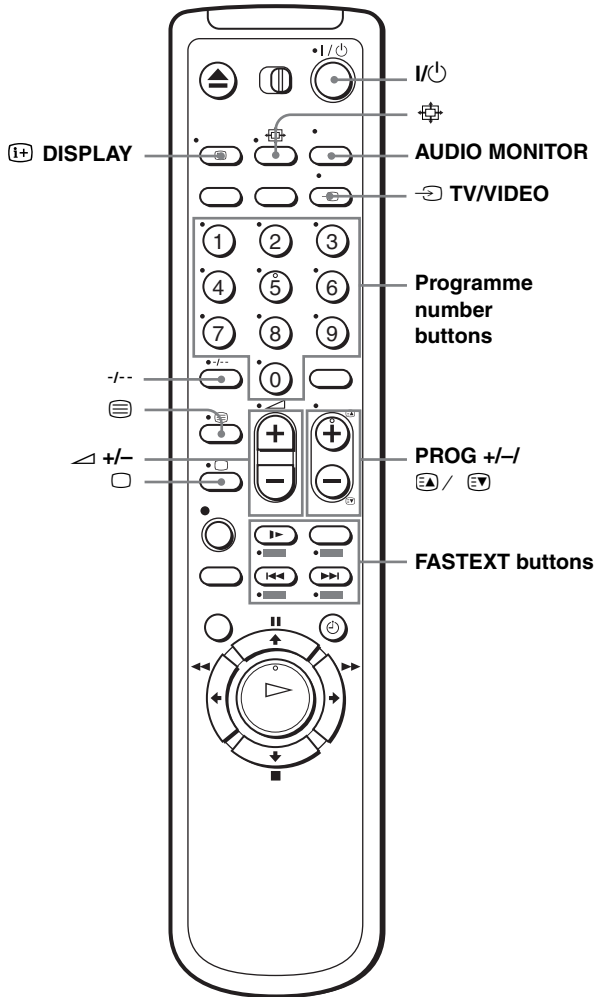

To operate	Set TV / VIDEO to
the VCR	VIDEO and point at the remote sensor at the VCR
a Sony TV	TV and point at the remote sensor at the TV



TV control buttons

To	Press
Set the TV to standby mode	I/Power
Select an input source: aerial in or line in	TV/VIDEO
Select the TV's programme position	Programme number buttons, -/--, PROG +/-
Adjust the volume of the TV	Volume +/-
Switch to TV (Teletext off)*1	TV (TV)

continued

To	Press
Switch to Teletext* ¹	 (Teletext)
Select the sound* ²	AUDIO MONITOR
Use FASTEXT* ¹	FASTEXT buttons
Call up the on-screen display	 DISPLAY
Change the Teletext page* ¹	 / 
Switch to/from wide mode of a Sony wide TV (For other manufactures' wide TVs, see "Controlling other TVs with the remote commander (SLV-SE830G only)" below.)	 (wide)

Notes



- With normal use, the batteries should last about three to six months.
- If you do not use the remote commander for an extended period of time, remove the batteries to avoid possible damage from battery leakage.
- Do not use a new battery together with an old one.
- Do not use different types of batteries together.
- Some buttons may not work with certain Sony TVs.



*¹ SLV-SE830G only

*² not available on SLV-SE230G/I













Controlling other TVs with the remote commander (SLV-SE830G only)

The remote commander is preprogrammed to control non-Sony TVs. If your TV is listed in the following table, set the appropriate manufacturer's code number.

1 Set  /  at the top of the remote commander to .

2 Hold down , and enter your TV's code number using the programme number buttons. Then release .

Now you can use the following TV control buttons to control your TV:

, , programme number buttons,  (ten's digit), , , , , FASTEXT buttons, * (wide)*, MENU*, / / / *, and OK*.

* These buttons may not work with all TVs.

Code numbers of controllable TVs



If more than one code number is listed, try entering them one at a time until you find the one that works with your TV.





To switch to wide mode, see the footnotes below this table for the applicable code numbers.

Manufacturer	Code number
Sony	01* ¹ , 02
Akai	68
Ferguson	52
Grundig	10* ¹ , 11* ¹
Hitachi	24
JVC	33
Loewe	45
Mivar	09, 70
NEC	66
Nokia	15, 16, 69* ³

Manufacturer	Code number
Panasonic	17* ¹ , 49
Philips	06* ¹ , 07* ¹ , 08* ¹
Saba	12, 13
Samsung	22, 23
Sanyo	25
Sharp	29
Telefunken	36
Thomson	43* ²
Toshiba	38

*1 Press  (wide) to switch the wide picture mode on or off.

*2 Press  (wide), then press  +/- to select the wide picture mode you want.

*3 Press  (wide). The menu appears on the TV screen. Then, press /// to select the wide picture you want and press OK.

Tip

- When you set your TV's code number correctly while the TV is turned on, the TV turns off automatically.

Notes

- If you enter a new code number, the code number previously entered will be erased.
- If the TV uses a different remote control system from the one programmed to work with the VCR, you cannot control your TV with the remote commander.
- When you replace the batteries of the remote commander, the code number may change. Set the appropriate code number every time you replace the batteries.

Step 3 : Connecting the VCR

If your TV has a Scart (EURO-AV) connector, see page 17.

If your TV does not have a Scart (EURO-AV) connector

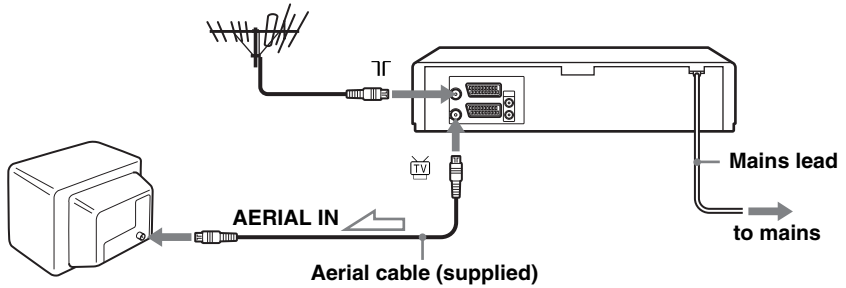

 : Signal flow

1

Disconnect the aerial cable from your TV and connect it to  on the rear panel of the VCR.

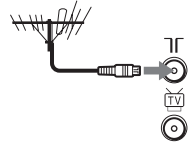

2

Connect  of the VCR and the aerial input of your TV using the supplied aerial cable.

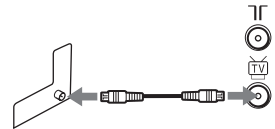

3

Connect the mains lead to the mains.

Note

- When you connect the VCR and your TV only with an aerial cable, you have to tune your TV to the VCR (see page 20).

If your TV has a Scart (EURO-AV) connector

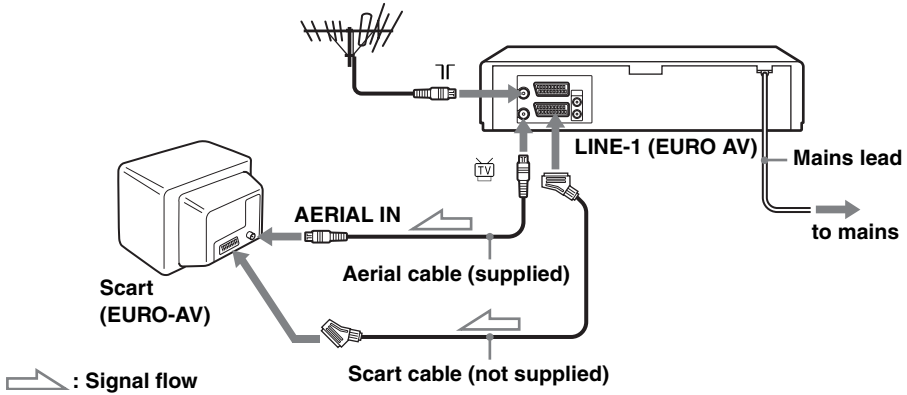

1

Disconnect the aerial cable from your TV and connect it to π on the rear panel of the VCR.

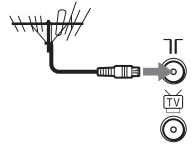

2

Connect TV of the VCR and the aerial input of your TV using the supplied aerial cable.

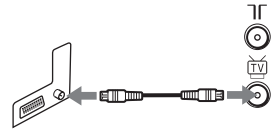

3

Connect LINE-1 (EURO AV) on the VCR and the Scart (EURO-AV) connector on the TV with the optional Scart cable.

This connection improves picture and sound quality. Whenever you want to watch the VCR picture, press \rightarrow TV/VIDEO to display the VIDEO indicator in the display window.

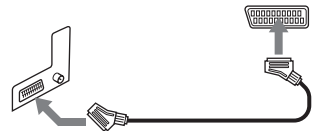

4

Connect the mains lead to the mains.

continued

About the SMARTLINK features (not available on SLV-SE230G/I)

If the connected TV complies with SMARTLINK, MEGALOGIC*¹, EASYLINK*², Q-Link*³, EURO VIEW LINK*⁴, or T-V LINK*⁵, this

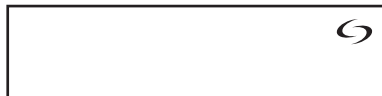

VCR automatically runs the SMARTLINK function after you complete the steps on the previous page (the ↻ indicator appears in the VCR's display window when you turn on the TV). You can enjoy the following SMARTLINK features.

- **TV Direct Rec**
You can easily record what you are watching on the TV when the VCR is turned on. For details, see “Recording what you are watching on the TV (TV Direct Rec) (not available on SLV-SE230G/I)” on page 39.
- **One Touch Play**
With One Touch Play, you can start playback automatically without turning on the TV. For details, see “Starting playback automatically with one button (One Touch Play) (not available on SLV-SE230G/I)” on page 35.
- **One Touch Menu**
When the VCR is turned on, you can turn on the TV, set the TV to the video channel, and display the VCR's on-screen display automatically by pressing MENU on the remote commander.
- **One Touch Timer**
When the VCR is turned on, you can turn on the TV, set the TV to the video channel, and display the timer recording menu (the TIMER PROGRAMMING menu or the VIDEOPLUS menu) automatically by pressing ⏸ TIMER on the remote commander.
You can set which timer recording menu is displayed using TIMER METHOD in the EASY OPERATION menu (see page 64).
- **NexTView Download**
You can easily set the timer by using the NexTView Download function on your TV. Please refer to your TV's instruction manual.

*¹ “MEGALOGIC” is a registered trademark of Grundig Corporation.

*² “EASYLINK” is a trademark of Philips Corporation.

*³ “Q-Link” is a trademark of Panasonic Corporation.

*⁴ “EURO VIEW LINK” is a trademark of Toshiba Corporation.

*⁵ “T-V LINK” is a trademark of JVC Corporation.

Note

- Not all TVs respond to the functions above.

Additional connections

To a stereo system (not available on SLV-SE230G/I)

You can improve sound quality by connecting a stereo system to the AUDIO R, L jacks as shown on the right.

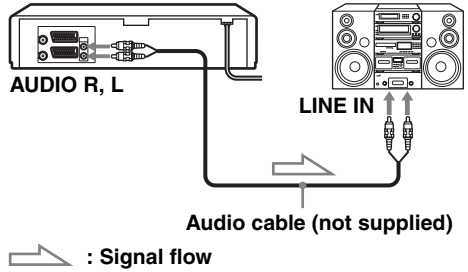

To a satellite or digital tuner with Line Through

Using the Line Through function, you can watch programmes from a satellite or digital tuner connected to this VCR on the TV even when the VCR is turned off. When you turn on the satellite or digital tuner, this VCR automatically sends the signal from the satellite or digital tuner to the TV without turning itself on.

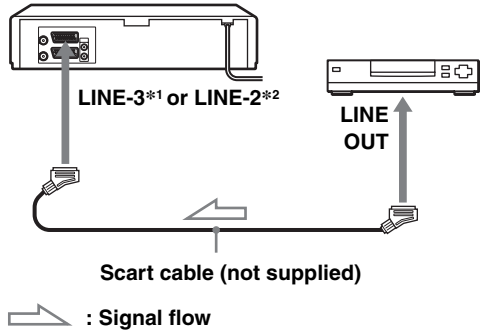

- 1** Connect the satellite or digital tuner to the LINE-3*1 or LINE-2*2 connector as shown above.
- 2** Turn off the VCR.
To watch a programme, turn on the satellite or digital tuner and the TV.

Notes

- The Line Through function will not operate properly if POWER SAVE in the USER SET menu is set to ECO2. Set POWER SAVE to OFF or ECO1 to ensure proper operation (see page 62).
- You cannot watch programmes on the TV while recording unless you are recording a satellite or digital programme.
- This function may not work with some types of satellite or digital tuners.
- When the VCR is turned off, set the TV to the video channel.

*1 SLV-SE830G only

*2 SLV-SE730G/I and SE230G/I only

Step 4 : Setting up the VCR with the Auto Set Up function

Before using the VCR for the first time, set up the VCR using the Auto Set Up function. With this function, you can set the TV channels, guide channels for the VIDEO Plus+ system, and VCR clock automatically.

1 Turn on your TV and set it to the video channel.
If your TV does not have a Scart (EURO-AV) connector, tune the TV to channel 21 (the initial RF channel for this VCR). Refer to your TV's manual for TV tuning instructions. If the picture does not appear clearly, see "To change the RF channel" on page 20.

2 Connect the mains lead to the mains.
The VCR automatically turns on, and the message for the Auto Set Up function appears.

3  Press OK.
The VCR starts searching for all of the receivable channels and presets them in the appropriate order for your local area.

If you want to change the order of the channels or disable unwanted programme positions, see "Changing/disabling programme positions" on page 27.

After the search or download is complete, the current time appears for any stations that transmit a time signal. If the time does not appear, set the clock manually. See "Setting the clock" on page 32.

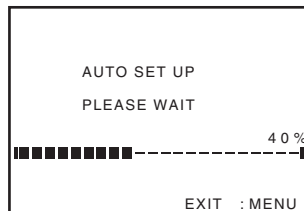

To cancel the Auto Set Up function

Press MENU.

To change the RF channel

If the picture does not appear clearly on the TV, change the RF channel on the VCR and TV. Select INSTALLATION from the menu, then press **↑/↓** to highlight VCR OUTPUT CH and press **→**. Select the RF channel by pressing the **↑/↓** buttons. Then, tune the TV to the new RF channel so that a clear picture appears.

Notes

- Whenever you operate the Auto Set Up function, some of the settings (VIDEO Plus+, timer, etc.) will be reset. If this happens, you have to set them again.
- Auto preset starts automatically only when you plug in the mains lead for the first time after you purchase the VCR.
- If you want to use the Auto Set Up function again, press MENU, then press **↑/↓/←/→** to highlight INSTALLATION and press OK. Press **↑/↓** to highlight AUTO SET UP, then repeat the procedure in step 3.
- Auto preset can be performed by pressing **■** (stop) on the VCR continuously for 5 seconds or more with no tape inserted.

Downloading the TV tuner's preset data (not available on SLV-SE230G/I)

You can download your TV tuner's preset data to the VCR and tune the VCR according to that data using the SMARTLINK connection.

Before you start...



- Turn on the VCR and the TV.
- Set the TV to the video channel.
- Refer to "Index to parts and controls" for button locations.

1

MENU

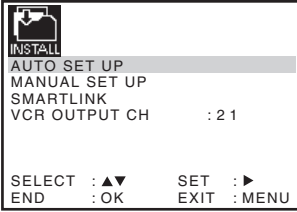

Press MENU, then press **↑/↓/←/→** to highlight INSTALLATION and press OK.



The TV menu screen displays the following options:

```
INSTALL
AUTO SET UP
MANUAL SET UP
SMARTLINK
VCR OUTPUT CH      : 2 1

SELECT : ▲▼      SET  : ►
END    : OK       EXIT : MENU
```

2

Press **↑/↓** to highlight SMARTLINK, then press **→**.

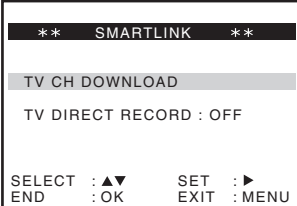



The TV menu screen displays the following options:

```
** SMARTLINK **
TV CH DOWNLOAD
TV DIRECT RECORD : OFF

SELECT : ▲▼      SET  : ►
END    : OK       EXIT : MENU
```

3



Press **↑/↓** to highlight TV CH DOWNLOAD, then press **→**. The Preset Download function starts and the  indicator flashes in the display window during download.



The TV menu screen displays the following options:

```
TV CH DOWNLOAD
PLEASE WAIT
■■■■■■■■■■----- 40%
END    : OK       START: ►
EXIT  : MENU
```

Selecting a language

If you prefer an on-screen language other than English, use the on-screen display to select another language.

Before you start...

- Turn on the VCR and the TV.
- Set the TV to the video channel.
- Refer to “Index to parts and controls” for button locations.

1

MENU



Press MENU, then press **↑/↓/←/→** to highlight LANGUAGE SET and press OK.

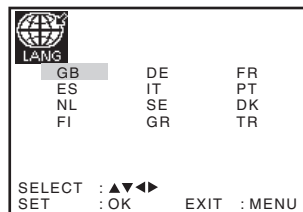

2



Press **↑/↓/←/→** to highlight the abbreviation of the desired language from the table below, then press OK.

The abbreviations of the languages are as follows:

Abbreviation	Language
GB	English
ES	Spanish
NL	Dutch
FI	Finnish
DE	German
IT	Italian

Abbreviation	Language
SE	Swedish
GR	Greek
FR	French
PT	Portuguese
DK	Danish
TR	Turkish

Presetting channels

If some channels could not be preset using the Auto Set Up function, you can preset them manually.

Before you start...

- Turn on the VCR and the TV.
- Set the TV to the video channel.
- Refer to "Index to parts and controls" for button locations.

1

MENU



Press MENU, then press **↑/↓/←/→** to highlight INSTALLATION and press OK.

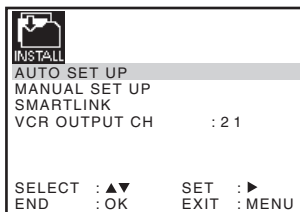

2



Press **↑/↓** to highlight MANUAL SET UP, then press **→**.

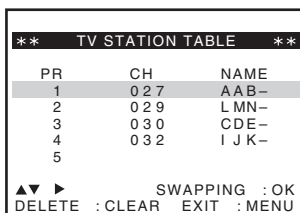

3



Press **↑/↓** to highlight the row which you want to preset, then press **→**.

To display other pages for programme positions 6 to 80, press **↑/↓** repeatedly.

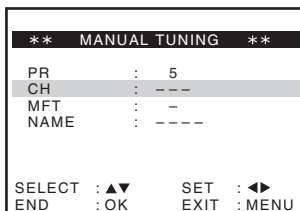

4



Press **←/→** repeatedly until the channel you want is displayed.

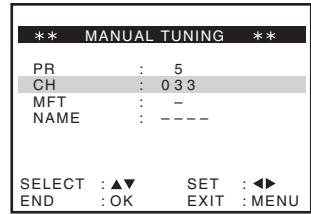

5



Press **↑/↓** to highlight NAME, then press **→**.

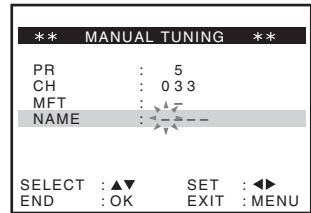

6



Enter the station name.

1 Press **↑/↓** to select a character. Each time you press **↑**, the character changes as shown below.

A → B → ... → Z → 0 → 1 → ... → 9 → A

2 Press **→** to set the next character.

The next space flashes.

To correct a character, press **←/→** until the character you want to correct flashes, then reset it.

You can set up to 4 characters for the station name.

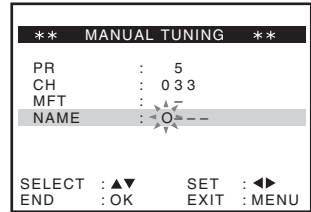

7



Press OK to confirm the station name.

8



Press MENU to exit the menu.

continued

If the picture is not clear

If the picture is not clear, you may use the Manual Fine Tuning (MFT) function. After step 4, press **↑/↓** to select MFT. Press **←/→** to get a clear picture, then press MENU to exit the menu.

Tip

- The VCR must receive channel information for station names to appear automatically.

Note

- When adjusting MFT, the menu may become difficult to read due to interference from the picture being received.

Changing/disabling programme positions

After setting the channels, you can change the programme positions as you like. If any programme positions are unused or contain unwanted channels, you can disable them.

You can also change the station names. If the station names are not displayed, you can enter them manually.

Changing programme positions

Before you start...

- Turn on the VCR and the TV.
- Set the TV to the video channel.
- Refer to "Index to parts and controls" for button locations.

1 Press MENU, then press **↑/↓/←/→** to highlight INSTALLATION and press OK.

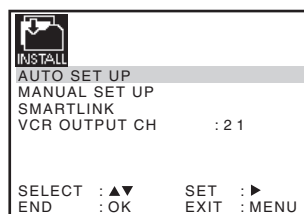
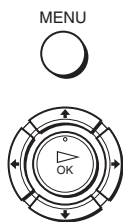

2 Press **↑/↓** to highlight MANUAL SET UP, then press **→**.



** TV STATION TABLE **		
PR	CH	NAME
1	027	AAB-
2	029	LMN-
3	030	CDE-
4	032	IJK-
5		

▲▼ ► SWAPPING : OK
DELETE : CLEAR EXIT : MENU

3 Press **↑/↓** to highlight the row containing the programme position you want to change.



To display other pages for programme positions 6 to 80, press **↑/↓** repeatedly.

** TV STATION TABLE **		
PR	CH	NAME
1	027	AAB-
2	029	LMN-
3	030	CDE-
4	032	IJK-
5		

▲▼ ► SWAPPING : OK
DELETE : CLEAR EXIT : MENU

continued

4



Press OK, then press **↑/↓** to move to the desired programme position.

** TV STATION TABLE **		
PR	CH	NAME
1	0 2 7	A A B-
2		
3	0 3 0	C D E-
4	0 3 2	F G H-
5	0 2 9	L M N-

▲▼ SWAPPING : OK
EXIT : MENU

5



Press OK to confirm the setting.

6

To change the programme position of another station, repeat steps 3 through 5.

7



Press MENU to exit the menu.

Disabling unwanted programme positions

After presetting channels, you can disable unused programme positions. The disabled positions will be skipped later when you press the PROG +/- buttons.

Before you start...

- Turn on the VCR and the TV.
- Set the TV to the video channel.
- Refer to “Index to parts and controls” for button locations.

1



Press MENU, then press **↑/↓/←/→** to highlight INSTALLATION, and press OK.



INSTALL	
AUTO SET UP	
MANUAL SET UP	
SMARTLINK	
VCR OUTPUT CH	: 2 1

SELECT : ▲▼ SET : ►
END : OK EXIT : MENU

2



Press **↑/↓** to highlight MANUAL SET UP, then press **→**.

** TV STATION TABLE **		
PR	CH	NAME
1	027	AAB-
2	029	LMN-
3	030	CDE-
4	032	IJK-
5		

▲▼ ► SWAPPING : OK
DELETE : CLEAR EXIT : MENU

3



Press **↑/↓** to highlight the row which you want to disable.

To display other pages for programme positions 6 to 80, press **↑/↓** repeatedly.

** TV STATION TABLE **		
PR	CH	NAME
1	027	AAB-
2	029	LMN-
3	030	CDE-
4	032	IJK-
5		

▲▼ ► SWAPPING : OK
DELETE : CLEAR EXIT : MENU

4



Press CLEAR.

The selected row will be cleared as shown on the right.

** TV STATION TABLE **		
PR	CH	NAME
1	027	AAB-
2		
3	030	CDE-
4	032	IJK-
5		

▲▼ ► SWAPPING : OK
DELETE : CLEAR EXIT : MENU

5

Repeat steps 3 and 4 for any other programme positions you want to disable.

6



Press MENU to exit the menu.

Note

- Be sure to select the programme position you want to disable correctly. If you disable a programme position by mistake, you need to reset that channel manually.

continued

Changing the station names

You can change or enter the station names (up to 4 characters). The VCR must receive channel information for station names to appear automatically.

Before you start...

- Turn on the VCR and the TV.
- Set the TV to the video channel.
- Refer to "Index to parts and controls" for button locations.

1

MENU



Press MENU, then press **↑/↓/←/→** to highlight INSTALLATION and press OK.

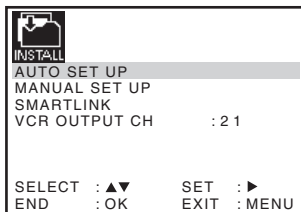

2



Press **↑/↓** to highlight MANUAL SET UP, then press **→**.

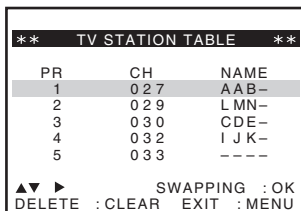

3



Press **↑/↓** to highlight the row which you want to change or enter the station name, then press **→**.

To display other pages for programme positions 6 to 80, press **↑/↓** repeatedly.

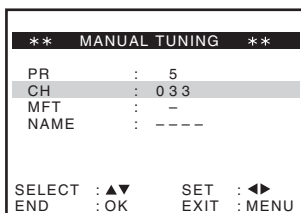

4



Press **↑/↓** to highlight NAME, then press **→**.

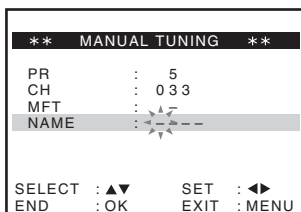

5



Enter the station name.

- 1 Press **↑/↓** to select a character.
Each time you press **↑**, the character changes as shown below.

A → **B** → ... → **Z** → **0** → **1** → ... → **9** → **A**

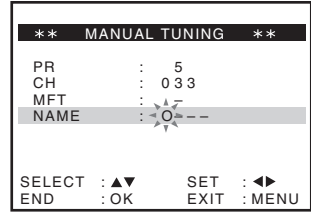

- 2 Press **→** to set the next character.

The next space flashes.

To correct a character, press **←/→** until the character you want to correct flashes, then reset it.

You can set up to 4 characters for the station name.

6



Press **OK** to confirm the new name.

7



Press **MENU** to exit the menu.

Setting the clock

You must set the time and date on the VCR to use the timer features properly.

The Auto Clock Set function works only if a station in your area is broadcasting a time signal.

Before you start...



- Turn on the VCR and the TV.
- Set the TV to the video channel.
- Refer to "Index to parts and controls" for button locations.

1

MENU

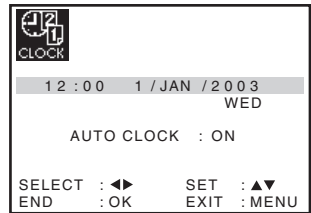

Press MENU, then press **↑/↓/←/→** to highlight CLOCK SET and press OK.



2



Press **↑/↓** to set the hour.

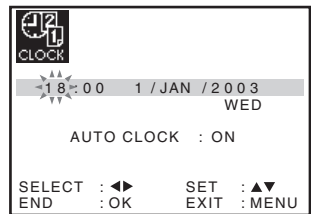

3



Press **→** to select the minutes and set the minutes by pressing **↑/↓**.

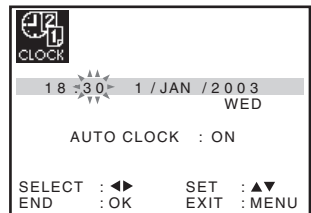

4



Set the day, month, and year in sequence by pressing \rightarrow to select the item to be set, and press \uparrow/\downarrow to select the digits, then press \rightarrow .

The day of the week is set automatically.

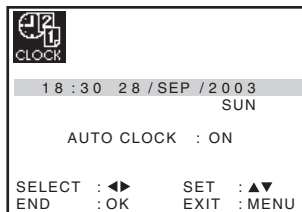

5



Press \uparrow/\downarrow to select ON for the setting of the Auto Clock Set function.

The VCR automatically sets the clock according to the time signal broadcast between the channels PR 1 to PR 5.

If you do not need the Auto Clock Set function, select OFF.

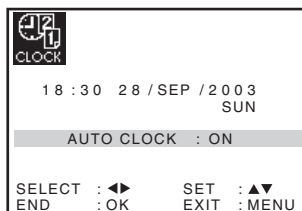

6



Press MENU to exit the menu.

Tips

- If you set AUTO CLOCK to ON, the Auto Clock Set function is activated whenever the VCR is turned off. The time is adjusted automatically by making reference to the time signal from the station.
- To change the digits while setting, press \leftarrow to return to the item to be changed, and select the digits by pressing \uparrow/\downarrow .

Playing a tape

Before you start...

- Refer to “Index to parts and controls” for button locations.

1 Turn on your TV and set it to the video channel.

2 Insert a tape.
The VCR turns on and starts playing automatically if you insert a tape with its safety tab removed.

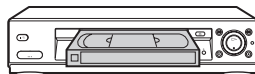

3 Press  (play).
When the tape reaches the end, it will rewind automatically.



Additional tasks

To	Press
Stop play	■ (stop)
Pause play	(pause)
Resume play after pause	(pause) or ▷ (play)
Fast-forward the tape	▶▶ (fast-forward) during stop
Rewind the tape	◀◀ (rewind) during stop
Eject the tape	▲ (eject)

To use the time counter

Press CLEAR at the point on the tape that you want to find later. The counter in the display window resets to “0:00:00” or “00:00.” Search for the point afterwards by referring to the counter.

SE830G, SE730G/I

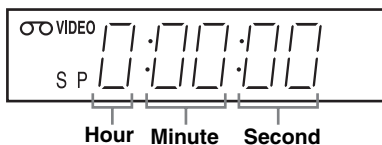

SE230G/I

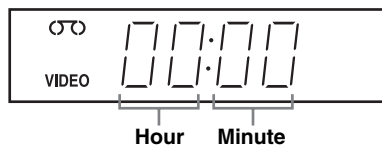

To display the counter on the TV screen, press  DISPLAY.

Notes

- The counter resets to “0:00:00” or “00:00” whenever a tape is reinserted.
- The counter stops counting when it comes to a portion with no recording.
- Depending on your TV, the following may occur while playing an NTSC-recorded tape:
 - The picture becomes black and white.
 - The picture shakes.
 - No picture appears on the TV screen.
 - Black streaks appear horizontally on the TV screen.
 - The colour density increases or decreases.
- While setting the menu on the TV screen, buttons for playback on the remote commander do not function.

Starting playback automatically with one button (One Touch Play) (not available on SLV-SE230G/I)

If you use the SMARTLINK connection, you can turn on the TV, set the TV to the video channel, and start playback automatically with one button.

1 Insert a tape.

The VCR automatically turns on.

If you insert a tape with its safety tab removed, the TV turns on and switches to the video channel. Playback starts automatically.

2 Press (play).

The TV turns on and switches to the video channel automatically. Playback starts.

Tip

- When there already is a tape in the VCR, press I/⏻ to turn on the VCR first. When you press  (play), the TV turns on, the TV is set to the video channel, and playback starts automatically in one sequence.

Note

- When you use the One Touch Play function, leave the TV on or in the standby mode.

Recording TV programmes

Before you start...

- Refer to “Index to parts and controls” for button locations.

1 Turn on your TV and set it to the video channel.
To record from a satellite or digital tuner, turn it on.

2 Insert a tape with its safety tab in place.

3 • To record a normal channel, press PROG +/- until the programme position number you want appears in the display window.



INPUT SELECT



• To record from other equipment connected to one or more of the LINE inputs, press INPUT SELECT until the connected line appears in the display window.



4 Press SP/LP to select the tape speed, SP or LP.



LP (Long Play) provides recording time twice as long as SP. However, SP (Standard Play) produces better picture and audio quality.

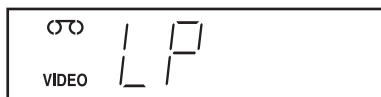

5



Press ● REC to start recording.

The recording indicator lights up in the display window.

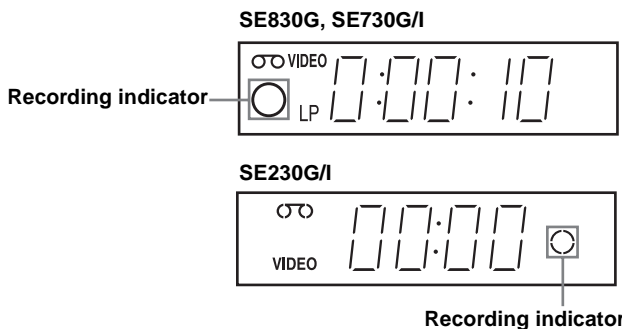

Basic Operations

To stop recording

Press ■ (stop).

To check the remaining time

Press **[F4]** DISPLAY twice. With the display on, press COUNTER/REMAIN to check the remaining time. Each time you press COUNTER/REMAIN, the time counter and the remaining time appear alternately.

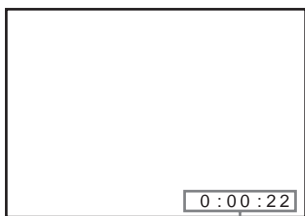

Time counter

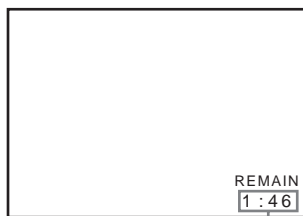

Remaining time

In order to get an accurate remaining time indication, be sure TAPE SELECT in the USER SET menu is set according to the tape type you use (see page 63).

To watch another TV programme while recording

- 1 Press **[TV]** TV/VIDEO to turn off the VIDEO indicator in the display window.
- 2 Select another programme position on the TV.

continued

To save a recording

To prevent accidental erasure, break off the safety tab as illustrated. To record on the same tape again, cover the tab hole with adhesive tape.

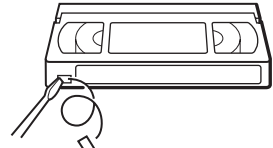

Safety tab

Tips

- To select a programme position, you can use the programme number buttons on the remote commander. For two-digit numbers, for example, press 2 and 3 to select “PR 23.”
- If you connect additional equipment to a LINE connector or jack, you can select the input signal using the INPUT SELECT or PROG +/- buttons.
- The **[+]** DISPLAY information appears on the TV screen indicating information about the tape, but the information will not be recorded on the tape.
- If you do not want to watch TV while recording, you can turn off the TV. When using a satellite or digital tuner, make sure to leave it on.

Notes

- The **[+]** DISPLAY information does not appear during still (pause) mode or slow-motion playback.
- If a tape has portions recorded in both PAL and NTSC systems, the time counter reading will not be correct. This discrepancy is due to the difference between the counting cycles of the two video systems.
- When you insert a non-standard commercially available tape, the remaining time may not be correct.
- The remaining time is intended for rough measurement only.
- About 30 seconds after the tape begins playback, the tape remaining time will be displayed.
- To use the TV Direct Rec function, select SMARTLINK in the INSTALLATION menu, then set TV DIRECT RECORD to ON.

Recording what you are watching on the TV (TV Direct Rec) (not available on SLV-SE230G/I)

If you use the SMARTLINK connection, you can easily record what you are watching on the TV (other than tapes being played on the VCR).

- 1 Press **I/⏻** to turn on the VCR.
- 2 Insert a tape with its safety tab in place.
- 3 Press **● REC** while you are watching a TV programme or external source.

The TV indicator lights up and the VCR starts recording what you are watching on the TV.

Tip

- The TV indicator appears in the display window after you press **● REC** in some situations such as:
 - when you are watching a source connected to the TV's line input, or
 - when the TV tuner preset data for the programme position is different from the data in the VCR tuner preset.

Notes

- You cannot record what you are watching using this method when the VCR is in the following modes; pause, timer standby, tuner preset, Auto Set Up, and recording.
- When the TV indicator is lit in the display window, do not turn off the TV nor change the TV programme position. When the TV indicator is not lit, the VCR continues recording the programme even if you change the TV programme position on the TV.
- To use the TV Direct Rec function, select SMARTLINK in the INSTALLATION menu, then set TV DIRECT RECORD to ON.

Recording TV programmes using the Dial Timer (SLV-SE830G only)

The Dial Timer function allows you to make timer recordings of programmes without turning on your TV. Set the recording timer to record up to eight programmes, including settings made with other timer methods, that will be broadcast within the next month. The recording start time and recording stop time can be set at one minute intervals.

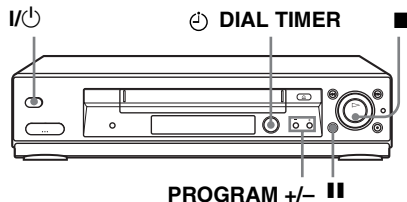

Before you start...

- Insert a tape with its safety tab in place. Make sure the tape is longer than the total recording time.
- To record from a satellite or digital tuner, turn it on.
- Refer to “Index to parts and controls” for button locations.

1

DIAL TIMER



Press  DIAL TIMER.

“DATE” and “TODAY” appear alternately in the display window.

If the date and time are not set, “DAY” will appear. See step 2 in the following section, “To set the clock” to set the date and time.

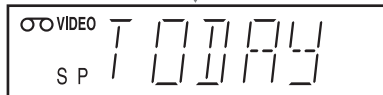



2

DIAL TIMER



Turn  DIAL TIMER to set the recording date.

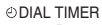

3  Press  DIAL TIMER.



“START” and the current time appear alternately in the display window.

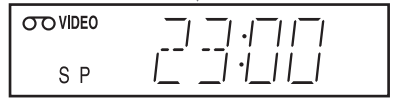

4  Turn  DIAL TIMER to set the recording start time.



You can set the recording start time in 15 minute intervals or adjust the time in one minute intervals by pressing the PROGRAM +/- buttons.

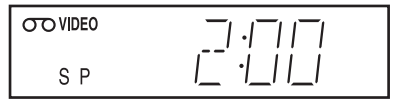
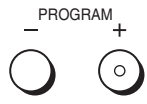

5  Press  DIAL TIMER.



“STOP” and the recording stop time alternately appear in the display window.

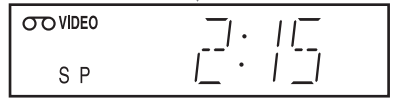

6  Turn  DIAL TIMER to set the recording stop time.



You can set the recording stop time in 15 minute intervals or adjust the time in one minute intervals by pressing the PROGRAM +/- buttons.

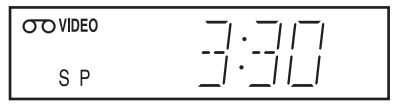

continued

7

⊖ DIAL TIMER



Press ⊖ DIAL TIMER.

The programme position or LINE input appears in the display window.

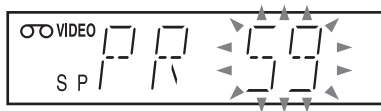

8

⊖ DIAL TIMER



Turn ⊖ DIAL TIMER to set the programme position.



INPUT SELECT



To record from other equipment connected to one or more of the LINE inputs, turn ⊖ DIAL TIMER or press INPUT SELECT to display the connected line in the display window.

9

⊖ DIAL TIMER



Press ⊖ DIAL TIMER to complete the setting.

“OK” appears in the display window for about five seconds.

The ⊖ indicator appears in the display window and the VCR stands by for recording.

To record from other equipment, leave the connected equipment switched on.

To return to the previous stepTo return to the previous step, press the PROGRAM + and – buttons on the VCR at the same time during any of the Dial Timer settings.**To stop recording**

To stop the VCR while recording, press ■ (stop).

To use the VCR after setting the timer

To use the VCR before a recording begins, just press I/⏻. The ⊖ indicator turns off and the VCR switches on. Remember to press I/⏻ to reset the VCR to recording standby after using the VCR.

You can also do the following tasks while the VCR is recording:

- Reset the counter (page 34).
- Display tape information on the TV screen (page 37).
- Check the timer settings (page 55).
- Watch another TV programme (page 37).

To set the clock

- 1** Hold down ⊖ DIAL TIMER so that “DAY” appears in the display window. However, if the clock has already been set, the current setting appears.
- 2** Turn ⊖ DIAL TIMER to set the day.
- 3** Press ⊖ DIAL TIMER.
“MONTH” appears in the display window.
- 4** Turn and press ⊖ DIAL TIMER to set the month, and then the year.
After you set the year, “CLOCK” appears in the display window again.
- 5** Turn and press ⊖ DIAL TIMER to set the hour and minute.
- 6** When you have finished setting the time, press ⊖ DIAL TIMER to start the clock.

Tips

- To cancel a Dial Timer setting, press ■ (stop) on the VCR while you are making the setting.
- The programme is recorded in the current tape speed mode. To change the tape speed, press SP/LP before you complete the setting in step 9.
- To check, change, or cancel the programme setting, see “Checking/changing/cancelling timer settings” on page 55.

Notes

- If eight programmes have already been set using the VIDEO Plus+ system or the TIMER PROGRAMMING menu, “FULL” appears in the display window for about five seconds.
- The ⊖ indicator flashes in the display window when you complete the setting in step 9 with no tape inserted.
- If you set the clock using the Auto Clock Set function and AUTO CLOCK is set to ON, the clock will adjust itself to the incoming time signal regardless of adjustments made with the Dial Timer. Be sure you have set the Auto Clock Set correctly.
- When the time is set incorrectly, “ERROR” appears in the display window in step 9. Set the timer again from step 1.
- You cannot set the tape speed to AUTO using the Dial Timer. To select AUTO, set the tape speed in the TIMER PROGRAMMING menu (see page 55).

continued

About the Demonstration Mode

The Dial Timer function has a Demonstration Mode that allows the user, such as a salesperson, to enter more than eight examples of timer settings when demonstrating the use of the Dial Timer. It cancels the “FULL” notice which appears if eight programmes have already been set. Do not use the Demonstration Mode for making timer recordings. Doing so may cause the settings to be inaccurate.

To activate the Demonstration Mode

Press **||** (pause) on the VCR while turning the **⊖** DIAL TIMER. “DEMO” appears in the display window for a few seconds.

To cancel the Demonstration Mode

Turn the power off and unplug the mains lead. Although the Demonstration Mode is cancelled, the timer settings entered while using the Demonstration Mode will remain. Be sure to manually cancel the timer settings before you use the Dial Timer or any other timer method after reconnecting the mains lead (see page 55).

Recording TV programmes using the VIDEO Plus+® system

The VIDEO Plus+ system is the feature that simplifies programming the VCR to make timer recordings. Just enter the PlusCode number listed in the TV programme guide. The date, times, and programme position of that programme are set automatically. You can preset a total of eight programmes, including settings made with other timer methods.



Before you start...

- Check that the VCR clock is set to the correct time and date.
- Insert a tape with its safety tab in place. Make sure the tape is longer than the total recording time.
- To record from a satellite or digital tuner, turn it on.
- Turn on your TV and set it to the video channel.
- Set TIMER METHOD to VIDEOPLUS or VARIABLE in the EASY OPERATION menu (see page 64).
- Refer to “Index to parts and controls” for button locations.

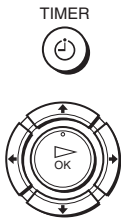
1



Press  TIMER.

- When you set TIMER METHOD to VARIABLE:
The TIMER METHOD menu appears on the TV screen. Press / to select VIDEOPLUS, then press OK.
- When you set TIMER METHOD to VIDEOPLUS:
The VIDEOPLUS menu appears on the TV screen.

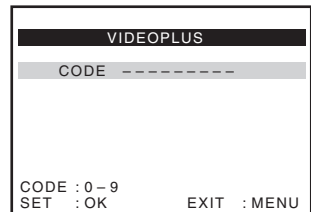
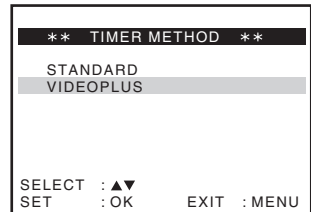

continued

2

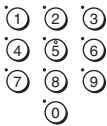

Press the programme number buttons to enter the PlusCode number.

If you make a mistake, press CLEAR and re-enter the correct number.

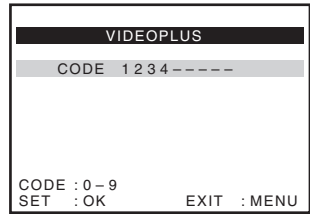

3



INPUT SELECT



CLEAR



Press OK.

The date, start and stop times, programme position, tape speed and PDC setting appear on the TV screen.

- If “--” appears in the “PR” (programme) column (this may happen for local broadcasts), you have to set the appropriate programme position manually. Press **↑/↓** to select the desired programme position.
- To record from other equipment connected to one or more of the LINE inputs, press INPUT SELECT to display the connected line in the “PR” position.

You will only have to do this operation once for the referred channel. The VCR will then store your setting.

If the information is incorrect, press CLEAR to cancel the setting.

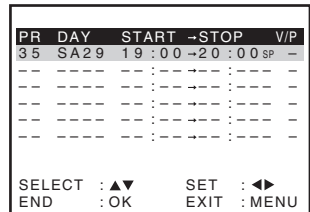

4



If you want to change the date, tape speed and the PDC setting:

- 1 Press **←/→** to select the item you want to change.
 - 2 Press **↑/↓** to reset it.
- To record the same programme every day or the same day every week, see “Daily/weekly recording” on page 47.
 - To use the PDC function, set V/P to ON. For details about the PDC function, see “Timer recording with PDC signals” on page 47.

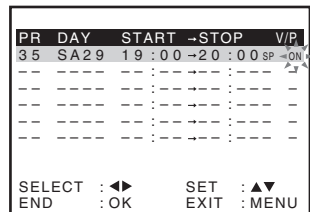

5

MENU



Press MENU to exit the menu.

6



Press **I/⏻** to turn off the VCR.

The **⊖** indicator appears in the display window and the VCR stands by for recording.

To record from a decoder or other source, leave the connected equipment switched on.

To stop recording

To stop the VCR while recording, press **■** (stop).

Daily/weekly recording

In step 4 above, press **↓** to select the recording pattern. Each time you press **↓**, the indication changes as shown below. Press **↑** to change the indication in reverse order.

today → **DLY (Monday to Sunday)** → **W-SA (every Saturday)** → **W-SU (every Sunday)** → **1 month later** → **(dates count down)** → **today**

Timer recording with PDC signals

Some broadcast systems transmit PDC (Programme Delivery Control) signals with their TV programmes. These signals ensure that your timer recordings are made regardless of broadcast delays, early starts, or broadcast interruptions.

To use the PDC function, set **V/P** to **ON** in step 4 above. You can also use the PDC function for a source connected to one or more of the **LINE** inputs.

To record satellite broadcasts

If you connect the satellite tuner and the VCR, you can record satellite programmes.

- 1** Turn on the satellite tuner.
- 2** On the satellite tuner, select the satellite programme for which you want to make a timer setting.
- 3** Keep the satellite tuner turned on until the VCR finishes recording the satellite programme for which you have made a timer setting.

To use the VCR after setting the timer

To use the VCR before a recording begins, just press **I/⏻**. The **⊖** indicator turns off and the VCR switches on. Remember to press **I/⏻** to reset the VCR to recording standby after using the VCR.

You can also do the following tasks while the VCR is recording:

- Reset the counter (page 34).
- Display tape information on the TV screen (page 37).
- Check the timer settings (page 55).
- Watch another TV programme (page 37).

To use the Auto Tape Speed function

In step 4 above, press **↓** to select AUTO. When you are recording a programme in the SP mode and the remaining tape length becomes shorter than the recording time, the recording tape speed is automatically changed to the LP mode. Note that some noise will appear on the picture when the tape speed is changed. To operate this function correctly, the “TAPE SELECT” setting in the USER SET menu must be accurate (see page 63).

Tips

- To set the line input video source, you can also use the INPUT SELECT button.
- You can set the extended time for the VIDEO Plus+ setting by 10, 20, 30, 40, 50, or 60 minutes. Set VIDEOPLUS EXTEND in the EASY OPERATION menu to the desired extended time on page 64.
- To check, change, or cancel the programme setting, see “Checking/changing/cancelling timer settings” on page 55.

Notes

- If the PDC signal is too weak or the broadcasting station failed to transmit PDC signals, the VCR will start recording at the set time without using the PDC function.
- The **⊖** and **⊕** indicators flash in the display window when you press **I/⏻** with no tape inserted.
- When you set TIMER METHOD to STANDARD in the EASY OPERATION menu, the VIDEOPLUS menu does not appear on the TV screen. Select VIDEOPLUS or VARIABLE.

Setting the timer manually

You can preset a total of eight programmes, including settings made with other timer methods.

Before you start...

- Check that the VCR clock is set to the correct time and date.
- Insert a tape with its safety tab in place. Make sure the tape is longer than the total recording time.
- To record from a satellite or digital tuner, turn it on.
- Turn on your TV and set it to the video channel.
- Set **TIMER METHOD** to **STANDARD** or **VARIABLE** in the **EASY OPERATION** menu (see page 64).
- Refer to “Index to parts and controls” for button locations.

1

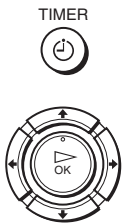

Press  **TIMER**.

- When you set **TIMER METHOD** to **VARIABLE**:
The **TIMER METHOD** menu appears on the TV screen. Press **↑/↓** to select **STANDARD**, then press **OK**.

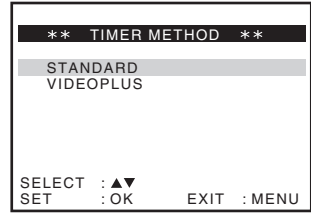

- When you set **TIMER METHOD** to **STANDARD**:
The **TIMER PROGRAMMING** menu appears on the TV screen.

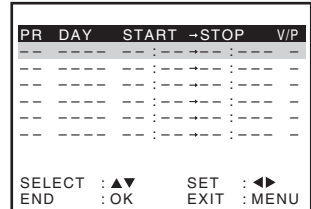

continued

2

INPUT SELECT



Set the date, start and stop times, programme position, tape speed and PDC function:

1 Press **→** to select each item in turn.

2 Press **↑/↓** to set each item.

To correct a setting, press **←** to return to that setting and reset.

PR	DAY	START	→STOP	V/P
3 5				
---	---	---	---	---
---	---	---	---	---
---	---	---	---	---
---	---	---	---	---
---	---	---	---	---
---	---	---	---	---

SELECT : **←** SET : **▲▼**
 END : **OK** EXIT : **MENU**

- To record the same programme every day or the same day every week, see “Daily/weekly recording” on page 50.
- To use the PDC function, set V/P to ON. For details about the PDC function, see “Timer recording with PDC signals” on page 47.
- To record from other equipment connected to one or more of the LINE inputs, press INPUT SELECT to display the connected line in the “PR” position.

3

MENU



Press MENU to exit the menu.

4

•I/⏻



Press **I/⏻** to turn off the VCR.

The **⊖** indicator appears in the display window and the VCR stands by for recording.

To record from other equipment, leave the connected equipment switched on.

To stop recording

To stop the VCR while recording, press **■** (stop).

Daily/weekly recording

In step 2 above, press **↓** to select the recording pattern. Each time you press **↓**, the indication changes as shown below. Press **↑** to change the indication in reverse order.

today → **DLY (Monday to Sunday)** → **W-SA (every Saturday) →**
W-SU (every Sunday) → 1 month later → (dates count down) → today

To use the VCR after setting the timer

To use the VCR before a recording begins, just press **I/⏻**. The **⊖** indicator turns off and the VCR switches on. Remember to press **I/⏻** to reset the VCR to recording standby after using the VCR.

You can also do the following tasks while the VCR is recording:

- Reset the counter (page 34).
- Display tape information on the TV screen (page 37).
- Check the timer settings (page 55).
- Watch another TV programme (page 37).

To use the Auto Tape Speed function

In step 2 above, press **↓** to select AUTO. When you are recording a programme in the SP mode and the remaining tape length becomes shorter than the recording time, the recording tape speed is automatically changed to the LP mode. Note that some noise will appear on the picture when the tape speed is changed. To operate this function correctly, the “TAPE SELECT” setting in the USER SET menu must be accurate (see page 63).

Tips

- To set the line input video source, you can also use the INPUT SELECT button.
- Even if you set TIMER METHOD to VIDEOPLUS in the EASY OPERATION menu, you can set the timer manually. Press MENU to select TIMER PROGRAMMING, then go to step 2.
- To check, change, or cancel the programme setting, see “Checking/changing/cancelling timer settings” on page 55.

Notes

- When setting the timer with PDC signals, enter the start and stop times exactly as indicated in the TV programme guide. Otherwise, the PDC function will not work.
- If the PDC signal is too weak or the broadcasting station failed to transmit PDC signals, the VCR will start recording at the set time without using the PDC function.
- The **⊖** and **⊖** indicators flash in the display window when you press **I/⏻** with no tape inserted.

Troubleshooting

If you have any questions or problems not covered below, please consult your nearest Sony service facility.

	Symptom	Remedy
Power	The I/⏻ (on/standby) switch does not function.	<ul style="list-style-type: none"> Connect the mains lead to the mains securely.
	The power is turned on but the VCR does not operate.	<ul style="list-style-type: none"> Moisture condensation has occurred. Turn the power off, unplug the mains lead and leave the VCR to dry for over three hours.
	The VCR is plugged in but the display window remains dark.	<ul style="list-style-type: none"> Set POWER SAVE in the USER SET menu to OFF (see page 62).
Clock	The clock has stopped and “- -: -” appears in the display window.	<ul style="list-style-type: none"> The clock stops if the VCR is disconnected from the mains. Reset the clock (and timer).
Playback	The playback picture does not appear on the TV screen.	<ul style="list-style-type: none"> Make sure the TV is set to the video channel. If you are using a monitor, set it to video input. If the VCR is connected to the TV with the Scart cable, make sure the VIDEO indicator is lit in the display window. Use the  TV/VIDEO button on the remote commander to light up the VIDEO indicator.
	The picture is not clear.	<ul style="list-style-type: none"> Existing broadcasts may interfere with the VCR. Reset the RF channel output of your VCR (see page 20). Adjust the tracking with the PROGRAM +/- buttons <u>on the VCR</u>. The video heads are dirty (see the last page of Troubleshooting). Clean the video heads using a Sony video head cleaning cassette. If a Sony cleaning cassette is not available in your area, have the heads cleaned at your nearest Sony service facility (a standard service charge will be required). Do not use a commercially available liquid type cleaning cassette other than Sony's, as it may damage the video heads. The video heads may have to be replaced. Consult your local Sony service facility for more information.
	The picture rolls vertically during picture search.	<ul style="list-style-type: none"> Adjust the vertical hold control on the TV or monitor.
	The picture has no sound.	<ul style="list-style-type: none"> The tape is defective. If you made A/V connections, check the audio cable connection.

	Symptom	Remedy
Playback	The sound from a tape recorded with the VCR is not in stereo or the STEREO indicator in the display window is flashing.	<ul style="list-style-type: none"> • Adjust the tracking. • The video heads are dirty. Clean the video heads using a Sony video head cleaning cassette as explained above.
Recording	No TV programme appears on the TV screen.	<ul style="list-style-type: none"> • Make sure the TV is set to the video channel. If you are using a monitor, set it to video input. • Existing broadcasts may interfere with the VCR. Reset the RF channel output of your VCR (see page 20). • Select the correct source with the INPUT SELECT button. Select a programme position when recording TV programmes; select a line input when recording from other equipment.
	TV reception is poor.	<ul style="list-style-type: none"> • Make sure the aerial cable is connected securely. • Adjust the TV aerial.
	The tape starts playing as soon as it is inserted.	<ul style="list-style-type: none"> • The safety tab has been removed. To record on this tape, cover the tab hole (see page 38).
	The tape is ejected when you press ● REC.	<ul style="list-style-type: none"> • The safety tab has been removed. To record on this tape, cover the tab hole (see page 38).
	Nothing happens when you press ● REC.	<ul style="list-style-type: none"> • Make sure the tape is not at its end.
Timer recording	The timer does not operate.	<ul style="list-style-type: none"> • Check that the clock is set. • Make sure a tape has been inserted. • Check that the safety tab has not been removed. • Make sure the tape is not at its end. • Make sure a programme has been set for timer recording. • Make sure your timer settings are past the current time. • Check that the digital tuner is turned on. • Check that the satellite tuner is turned on. • The clock stops if the VCR is disconnected from the mains. Reset the clock and timer. • Turn the power off and unplug the mains lead.
	The VIDEOPLUS menu or the TIMER PROGRAMMING menu does not appear.	<ul style="list-style-type: none"> • Check that TIMER METHOD in the EASY OPERATION menu is set correctly (see page 64).

	Symptom	Remedy
Timer recording	The PDC function does not operate properly.	<ul style="list-style-type: none"> • Check that the clock and the date are set correctly. • Check that the PDC time you set is the correct one (there might be a mistake in the TV programme guide). If the broadcast you wanted to record did not send the good PDC information, the VCR will not start recording. • If the reception is poor, the PDC signal might be altered and the VCR might not start recording.
	A tape cannot be inserted.	<ul style="list-style-type: none"> • Check that a tape is not already in the tape compartment.
Others	The remote commander does not function.	<ul style="list-style-type: none"> • Make sure you are pointing the remote commander at the remote sensor on the VCR. • Replace all the batteries in the remote commander with new ones if they are weak. • Make sure the [TV] / [VIDEO] remote control switch is set correctly.
	The selected input line connector number does not appear in the display window.	<ul style="list-style-type: none"> • Press INPUT SELECT to display the connected line.
	The tracking meter does not appear on the TV screen.	<ul style="list-style-type: none"> • The recording condition of the tape is very poor and tracking cannot be adjusted.
	You cannot control other TVs.	<ul style="list-style-type: none"> • Set your TV's code number. The code number may change when you replace the batteries of the remote commander.
	The display window becomes dim.	<ul style="list-style-type: none"> • The display window automatically becomes dim when the VCR is in standby or timer recording mode.
	The VCR needs to be cleaned.	<ul style="list-style-type: none"> • Clean the cabinet, panel and controls with a dry, soft cloth, or a soft cloth slightly moistened with a mild detergent solution. Do not use any type of solvent, such as alcohol or benzene.
	The Line Through function does not operate.	<ul style="list-style-type: none"> • Set POWER SAVE in the USER SET menu to OFF (see page 62).

Symptoms caused by contaminated video heads

• Normal picture



• Rough picture



initial
contamination

• Unclear picture



• No picture (or
black & white
screen appears)



terminal



Specifications

System

Channel coverage

PAL (I)

VHF IA to IJ, SA10 to SA13*

UHF B21 to B69

CATV S01 to S05, S1 to S20*

HYPER S21 to S41*

RF output signal

UHF channels 21 to 69

Aerial out

75-ohm asymmetrical aerial socket

Tape speed

SP:PAL23.39 mm/s (recording/playback)

NTSC33.35 mm/s (playback only)

LP:PAL11.70 mm/s (recording/playback)

NTSC16.67 mm/s (playback only)

EP:NTSC11.12 mm/s (playback only)

Maximum recording/playback time

10 hrs. in LP mode (with E300 tape)

Rewind time

Approx. 1 min. (with E180 tape)

* SLV-SE730I and SE230I only

Inputs and outputs

LINE-1 (EURO AV)

21-pin

Video input: pin 20

Audio input: pins 2 and 6

Video output: pin 19

Audio output: pins 1 and 3

LINE-2/LINE-3

21-pin

Video input: pin 20

Audio input: pins 2 and 6

↻ LINE-2 L ↻ R*¹

VIDEO IN, phono jack (1)

Input signal: 1 Vp-p, 75 ohms,
unbalanced, sync negative

AUDIO IN, phono jack (2)

Input level: 327 mVrms

Input impedance: more than 47 kilohms

AUDIO (OUT) R, L*²

Phono jack (2)

Rated output level: 327 mVrms

Load impedance: 47 kilohms

Output impedance: less than 10 kilohms

*¹ SLV-SE830G only

*² not available on SLV-SE230G/I

General

Power requirements

220 – 240 V AC, 50 Hz

Power consumption

• SLV-SE230G/I

15 W

1.2 W (POWER SAVE is set to ECO2,
minimum)

• SLV-SE830G, SE730G/I

17 W

1.3 W (POWER SAVE is set to ECO2,
minimum)

Operating temperature

5° C to 40° C

Storage temperature

-20° C to 60° C

Dimensions including projecting parts and controls (w/h/d)

Approx. 360 × 95 × 245 mm
(SLV-SE230G/I)

Approx. 430 × 96 × 245 mm
(SLV-SE730G/I)

Approx. 430 × 96 × 253 mm
(SLV-SE830G)

Mass

Approx. 2.8 kg (SLV-SE230G/I)

Approx. 3.1 kg (SLV-SE830G and
SE730G/I)

Supplied accessories

Remote commander (1)

R6 (size AA) batteries (2)

Aerial cable (1)

Design and specifications are subject to
change without notice.

Playing/searching at various speeds

Before you start...

- Refer to “Index to parts and controls” for button locations.

Playback options	Operation
View the picture during fast-forward or rewind	During fast-forward, hold down ►► (fast-forward). During rewind, hold down ◀◀ (rewind).
Play at high speed	<ul style="list-style-type: none"> • During playback, press ►► (fast-forward) or ◀◀ (rewind) <u>on the remote commander</u>. • During playback, hold down ►► (fast-forward) or ◀◀ (rewind). When you release the button, normal playback resumes.
Play at twice the normal speed	During playback, press ×2.
Play in slow motion	During playback, press ► SLOW.
Play frame by frame	During pause, press ►► (fast-forward) or ◀◀ (rewind)* <u>on the remote commander</u> .

* SLV-SE830G only

To resume normal playback

Press ▷ (play).

Using the shuttle ring (SLV-SE830G only)

With the shuttle ring, you can operate a variety of playback options. There are two ways for using the shuttle ring, normal mode and jog mode.

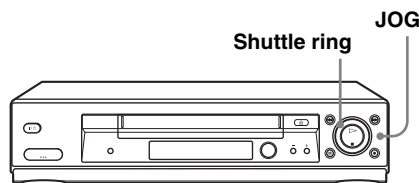

To use the shuttle ring in normal mode

During playback or pause, turn the shuttle ring clockwise or anticlockwise. Each change in the shuttle ring position changes the playback mode in the following way.

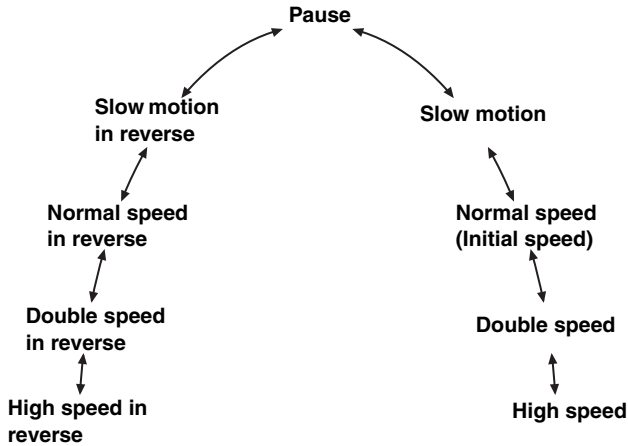

To use the shuttle ring in jog mode

Use this mode for frame-by-frame playback.

Press JOG to enter the jog mode. The JOG button lights up. If you change to the jog mode during any playback mode, playback pauses so you can see a still picture. Each change in the shuttle ring position shifts the picture one frame. To shift frames in reverse, turn the shuttle ring anticlockwise. The frame shift speed depends on the speed you turn the shuttle ring.

To resume normal mode, press JOG again. The JOG button turns off.

Tip

- Adjust the picture using the PROGRAM +/- buttons on the VCR if:
 - Streaks appear while playing in slow motion.
 - Bands appear at the top or bottom while pausing.
 - The picture shakes while pausing.
- To set tracking to the centre position, press both buttons (+/-) at the same time.

Notes

- The sound is muted during these operations.
- In the LP mode, noise may appear or there may be no colour.
- If the playback mode mark does not appear on the TV screen, press **[+] DISPLAY**.
- The picture may show noise when playing at high speed in reverse.
- The picture returns to normal playback from slow motion in reverse in 30 seconds.

Setting the recording duration time

After you have started recording in the normal way, you can have the VCR stop recording automatically after a specified duration.

Before you start...

- Refer to “Index to parts and controls” for button locations.

1 While recording, press ● REC.

The ⊖ indicator appears in the display window.



2 Press ● REC repeatedly to set the duration time.

In SP mode

Each press advances the time in increments of 30 minutes.

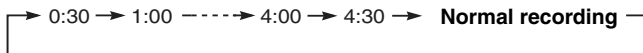

In LP mode

Each press advances the time as shown below.

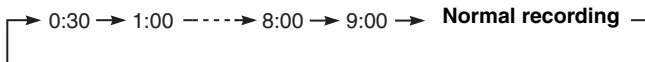

The tape counter decreases minute by minute to 0:00, then the VCR stops recording and turns off automatically.

To extend the duration

Press ● REC repeatedly to set a new duration time.

To cancel the duration

Press ● REC repeatedly until the ⊖ indicator disappears and the VCR returns to the normal recording mode.

To stop recording

To stop the VCR while recording, press ■ (stop).

Note

- You cannot display the current tape time in the display window when setting the recording duration time.

Checking/changing/cancelling timer settings

Before you start...

- Turn on your TV and set it to the video channel.
- Refer to “Index to parts and controls” for button locations.

1 Press I/⏻ to turn on the VCR.

2 Press MENU, then press ↑/↓ to highlight TIMER PROGRAMMING and press OK.

- If you want to change or cancel a setting, go on to the next step.
- If you do not need to change or cancel the settings, press MENU, then turn off the VCR to return to recording standby.

PR	DAY	START	→STOP	V/P
35	SA29	19:00	→20:00	SP ON
29	SA29	21:00	→21:30	--
30	SA 6	12:00	→13:30	--
--	--	--	--	--
--	--	--	--	--
--	--	--	--	--

SELECT : ▲▼ SET : ◀▶
END : OK EXIT : MENU

3 Press ↑/↓ to select the setting you want to change or cancel, then press →.

The PR number on the selected row flashes.

PR	DAY	START	→STOP	V/P
35	SA29	19:00	→20:00	SP ON
29	SA29	21:00	→21:30	--
30	SA 6	12:00	→13:30	--
11	--	--	--	--
--	--	--	--	--
--	--	--	--	--

SELECT : ▲▼ SET : ◀▶
END : OK EXIT : MENU

4 • To change the setting, press ←/→ to select the item you want to change, then press ↑/↓ to reset it.
• To cancel the setting, press CLEAR.

5 Press MENU to exit the menu.

If any settings remain, turn off the VCR to return to recording standby.

When the timer settings overlap

The programme that starts first has priority and the second programme starts recording only after the first programme has finished. If the programmes start at the same time, the programme listed first in the menu has priority.

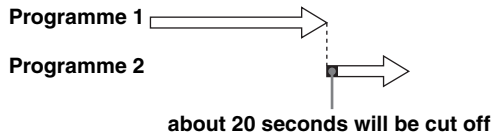
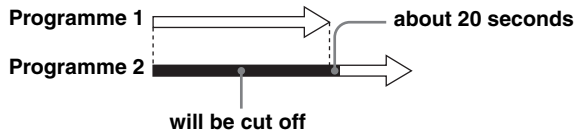

Recording stereo and bilingual programmes (not available on SLV-SE230G/I)

In the NICAM system

This VCR receives and records stereo and bilingual programmes based on the NICAM system (NICAM appears on the TV screen). When a stereo or bilingual programme is received, the STEREO indicator appears in the display window.

To record a NICAM programme, NICAM in the USER SET menu should be set to ON (initial setting). To check the menu setting, see page 63 for details.

To select the sound while recording

Press AUDIO MONITOR to select the sound you want.

Stereo programmes

To listen to	On-screen display	Display window
Stereo	NICAM, STEREO	STEREO
Left channel	NICAM, LCH	STEREO
Right channel	NICAM, RCH	STEREO
Left and right channels*	NICAM, LCH + RCH	STEREO

* Usually the mixed sound of left and right channels

Bilingual programmes

To listen to	On-screen display	Display window
Main	NICAM, MAIN	STEREO
Sub	NICAM, SUB	STEREO
Main and sub	NICAM, MAIN/SUB	STEREO
Standard sound*	NICAM, MONO	STEREO

* Usually the main sound (monaural)

continued

Selecting the sound during Hi-fi playback

Press AUDIO MONITOR to select the sound you want.

To listen to	On-screen display	Display window
Stereo	STEREO	STEREO
Left channel	LCH	STEREO
Right channel	RCH	STEREO
Mix sound*	MIX	STEREO
Mono sound	MONO	No indicator

* The mixed sound of left and right channels, and the normal mono audio track

How sound is recorded on a video tape

The VCR records sound onto two separate tracks. Hi-fi audio is recorded onto the main track along with the picture. Monaural sound is recorded onto the normal audio track along the edge of the tape.

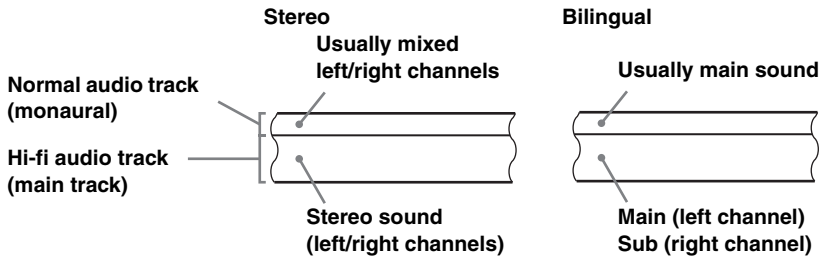

Notes

- To listen to playback sounds in stereo, you must use the Scart or AUDIO OUT connections.
- When you play a tape recorded in monaural, the sound is heard in monaural regardless of the AUDIO MONITOR setting.

Searching using the index function (not available on SLV-SE230G/I)

The VCR automatically marks the tape with an index signal at the point where each recording begins. Use these signals as references to find a specific recording.

To find a specific recording by scanning (Index scan)

- 1 Insert an indexed tape into the VCR.
- 2 Press **⏮/⏭** (index search). The VCR starts scanning each recording for five seconds in the corresponding direction.

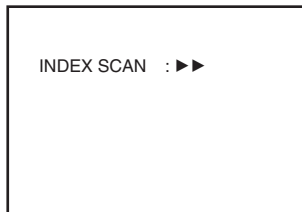

- 3 Press **▶** (play) to start playback when you find the desired point.

To search a specific recording (Index search)

- 1 Insert an indexed tape into the VCR.
- 2 Press **⏮/⏭** (index search) twice.
 - To search ahead, press **⏭** (index search) twice.
 - To search backwards, press **⏮** (index search) twice.



- 3 Press **⏮/⏭** (index search) depending on the direction where your desired programme is located.

Each time you press the button, the number increases or decreases up to ± 20 , respectively.

- 4 The VCR starts searching, and playback starts automatically from that point.

To stop searching

Press **■** (stop).

Notes

- No index signal will be added when recording starts from recording pause. However, an index signal will be marked if you change the programme position during recording pause.
- When you press **⏮** (index search), if there is nothing recorded before the selected index signal, playback may not start exactly at the index signal.

Adjusting the picture

Adjusting the tracking

Although the VCR automatically adjusts the tracking when playing a tape, distortion may occur if the recording is in poor condition. In this case, manually adjust the tracking.

During playback, press **PROGRAM +/-** on the **VCR** to display the tracking meter. The distortion should disappear as you press one of the two buttons. To resume automatic tracking adjustments, eject the tape and re-insert it.

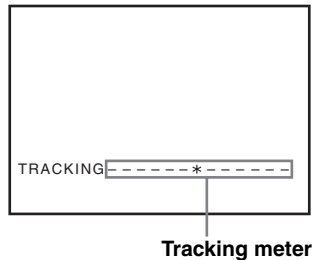

Adjusting the picture sharpness (Smart trilogic)

You can automatically adjust the sharpness of the picture.

1 During playback, press **MENU**, then press **↑/↓/←/→** to highlight **USER SET** and press **OK**.

2 Press **↑/↓** to highlight **SMART TRILOGIC**, then press **→**.

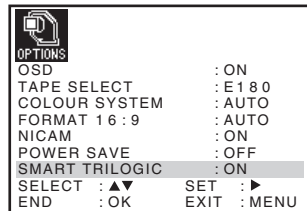

3 Press **↑/↓** to set **SMART TRILOGIC** to **ON** or **OFF**.

- **ON:** Picture sharpness is automatically adjusted.
- **OFF:** Adjust the picture sharpness manually.
To soften the picture, press **←**.
To sharpen the picture, press **→**.

4 Press **MENU** to return to the original screen.

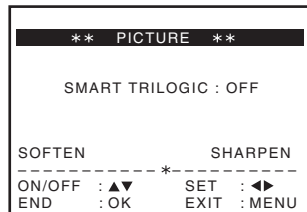

Reducing the VCR's power consumption

You can turn off the indicators in the display window when the VCR is off (standby mode) to reduce the VCR's power consumption.

- 1 Press MENU, then press **↑/↓/←/→** to highlight USER SET and press OK.
- 2 Press **↑/↓** to highlight POWER SAVE.
- 3 Press **→** to set to ECO1 or ECO2, then press OK.
 - ECO1: To reduce the power consumption.
 - ECO2: To reduce the power consumption to a minimum.

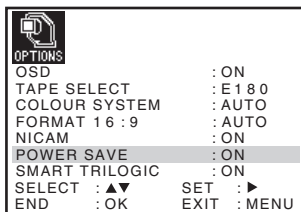

To turn on the indicators in the display window

Set POWER SAVE to OFF in step 3.

Notes

- When the VCR stands by for recording, the \odot indicator in the display window remains lit even when POWER SAVE is set to ECO1 or ECO2.
- The Line Through function will not operate properly if POWER SAVE is set to ECO2. Set POWER SAVE to OFF or ECO1 to ensure proper operation.

Changing menu options

- 1 Press MENU, then select USER SET or EASY OPERATION and press OK.

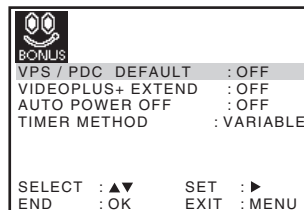
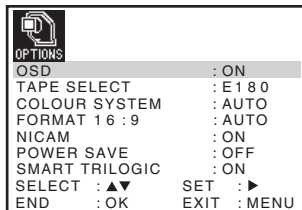

- 2 Press **↑/↓** to select the option.
- 3 Press **→** to change the setting, then press OK.

Menu choices

Initial settings are indicated in bold print.



USER SET

Menu option	Set this option to
OSD	<ul style="list-style-type: none"> • ON to display the menu on the TV screen. • OFF to disappear the menu from the TV screen.
TAPE SELECT	<ul style="list-style-type: none"> • E180 to use an E-180 or shorter type tape. • E240 to use an E-240 type tape. • E260 to use an E-260 type tape. • E300 to use an E-300 type tape.
COLOUR SYSTEM	<ul style="list-style-type: none"> • AUTO to select the colour system automatically. • PAL to use the tape recorded in the PAL colour system. • B/W to use the tape recorded in black and white.
FORMAT 16:9	<ul style="list-style-type: none"> • AUTO when you use a wide screen TV. The VCR automatically detects if programmes being played back or recorded are in normal or wide screen format. • ON if the VCR cannot detect wide screen TV programmes with AUTO. The VCR always plays back and records in wide screen format. • OFF if you are not using a wide screen TV.
NICAM	<ul style="list-style-type: none"> • ON to record NICAM broadcasts on the hi-fi audio track. • OFF to record standard sound on the hi-fi audio track. <p>For details, see page 57.</p>

continued

Menu option	Set this option to
POWER SAVE	<ul style="list-style-type: none"> • ECO1 to turn off the indicators in the display window to conserve the VCR's power. • ECO2 to turn off the indicators in the display window during standby mode to reduce the VCR's power consumption to a minimum. For using the Line Through function, select ECO1 or OFF. • OFF to turn on the indicators in the display window while the VCR is standing by.
SMART TRILOGIC	<ul style="list-style-type: none"> • ON to automatically adjust the sharpness of the picture. • OFF to manually adjust the sharpness of the picture.

EASY OPERATION

Menu option	Set this option to
VPS/PDC DEFAULT	<ul style="list-style-type: none"> • OFF to deactivate the PDC function. • ON to activate it.
VIDEOPLUS EXTEND	<ul style="list-style-type: none"> • OFF to deactivate the VIDEO Plus+ Extend function. • 10/20/30/.../60 (minutes) to extend the time of the VIDEO Plus+ setting by the selected amount of time.
AUTO POWER OFF	<ul style="list-style-type: none"> • OFF to deactivate the Auto Power Off function. • 2HOUR/3HOUR to turn the VCR off automatically if no signal is received and you do not press any of the buttons during this time.
TIMER METHOD	<ul style="list-style-type: none"> • VARIABLE to display the TIMER METHOD menu for selecting STANDARD or VIDEOPLUS when pressing the  TIMER button. • STANDARD to display the TIMER PROGRAMMING menu when pressing the  TIMER button. • VIDEOPLUS to display the VIDEOPLUS menu when pressing the  TIMER button. <p>For details, see pages 45 and 49.</p>

Connecting to a VCR or stereo system

How to connect to record on this VCR

Connect the line outputs of the other VCR to the input connector of this VCR. Refer to the examples A through C and choose the connection that best suits your VCR.

Example A

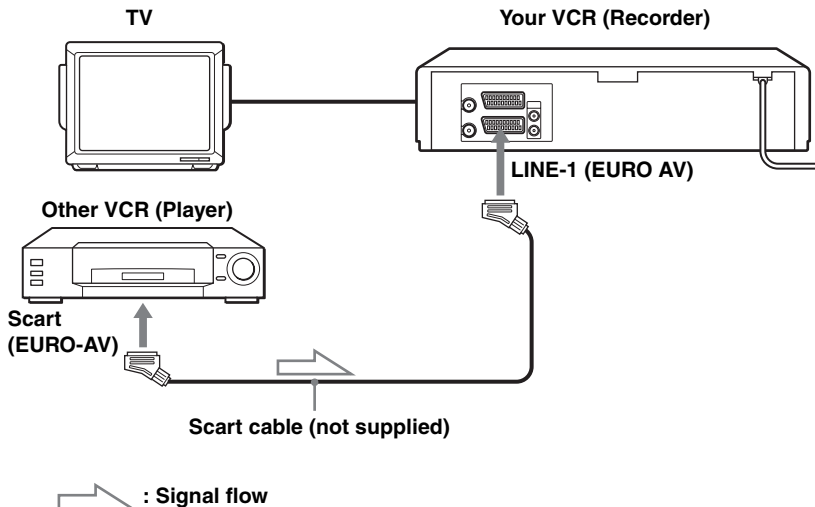

Example B (SLV-SE830G only)

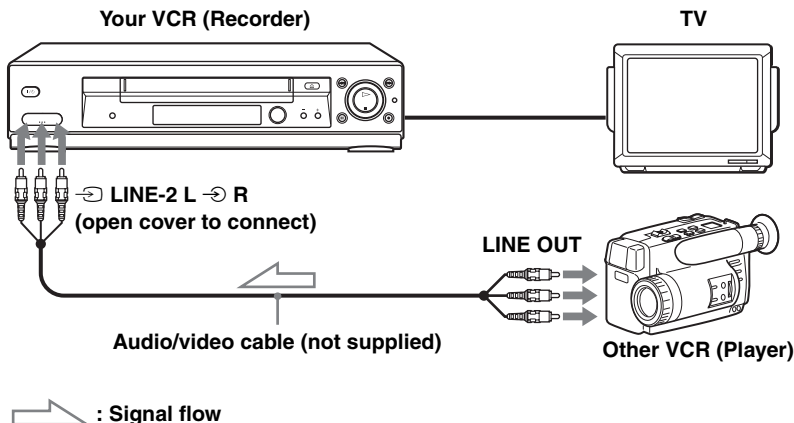

continued

Example C

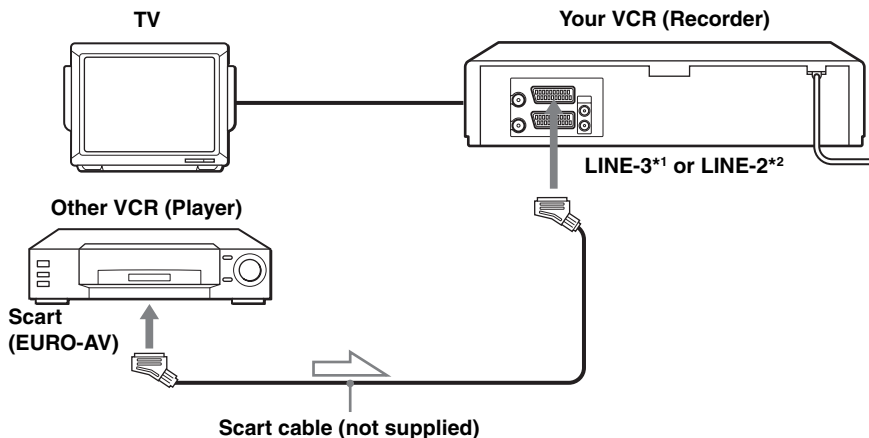

 : Signal flow

How to connect to a stereo system (SLV-SE830G only)

Connect the \rightarrow LINE-2 L \rightarrow R jacks on this VCR to the audio output jacks on the stereo system, using an audio cable (not supplied).

Notes

- Make sure you connect the plugs to jacks of the same colour.
- If the other VCR is a monaural type, leave the red plugs unconnected.
- If you connect this VCR to both the LINE IN and LINE OUT jacks of the other VCR, select the input correctly to prevent a humming noise.
- If the other VCR does not have a Scart (EURO-AV) connector, use an adequate cable instead and connect the cable to the line out jacks of the other VCR.
- When you connect another VCR to the LINE-3*1 or LINE-2*2 connector, press INPUT SELECT to display "L3"*1 or "L2"*2 in the display window.

*1 SLV-SE830G only

*2 SLV-SE730G/I and SE230G/I only

Basic editing

When recording on this VCR

Before you start editing

- Turn on your TV and set it to the video channel.
- Press INPUT SELECT to display the connected line in the display window.
- Press SP/LP to select the tape speed, SP or LP.

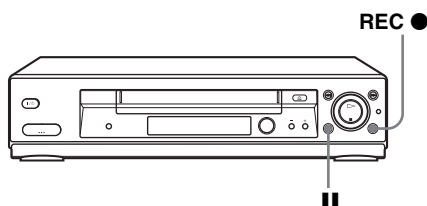

- 1** Insert a source tape with its safety tab removed into the other (playback) VCR. Search for the point to start playback and set it to playback pause.
- 2** Insert a tape with its safety tab in place into this (recording) VCR. Search for the point to start recording and press **||** (pause) to set it to playback pause.
- 3** Press **REC ●** on this VCR to set it to recording pause.
- 4** To start editing, press the **||** (pause) buttons on both VCRs at the same time.

To stop editing

Press the **■** (stop) buttons on both VCRs.



Tip

- To cut out unwanted scenes while editing, press **||** (pause) on this VCR when an unwanted scene begins. When it ends, press **||** (pause) again to resume recording.



Audio dubbing (SLV-SE830G only)

This feature lets you record over the normal audio track. The monaural sound previously recorded is replaced while the original hi-fi sound remains unchanged. Use this feature to add commentary to a tape that you have recorded with a camcorder.

Before you start...

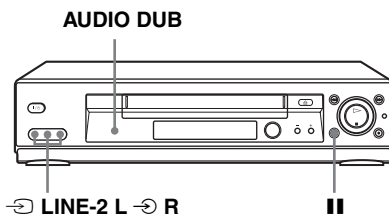
- Open the  LINE-2 L  R jacks cover on the front panel and connect a playback source.
- Turn on the TV and set it to the video channel.



- 1** Insert a source tape into your stereo system (or the playback VCR). Search for the point to start playback and set it to playback pause.
- 2** Insert a prerecorded tape with its safety tab in place into this (recording) VCR. Search for the start of the section to be replaced and press  (pause).
The VCR enters pause mode.
- 3** Press AUDIO DUB.
“A_DUB” and the  indicator appears in the display window.
- 4** To start editing, press the  (pause) buttons on this VCR and the stereo system (or other VCR) at the same time.
After you use this feature, the audio in playback mode is automatically set to monaural.

To stop editing

Press  (stop) on this VCR and the stereo system (or other VCR).

Index

A

- Adjusting
 - picture 61
 - tracking 61
- Aerial hookup 16
- Audio dubbing 68
- Audio track 58
- Auto Clock Set 20
- Auto Set Up 20

C

- Changing the programme position 27
- Changing the station name 30
- Cleaning the video heads 69
- Clock setting 32
- Colour system
 - compatible colour systems 2
- Connecting
 - the VCR and your TV 16, 17
 - to a stereo system 19, 65
 - to a TV with a Scart (EURO-AV) connector 17
 - to digital tuner 19
 - to satellite tuner 19
- Counter 34

D

- Demonstration 44
- Dial Timer 40
- Disabling the programme positions 28
- Dubbing. *see* Editing

E

- Editing 65

H

- Hi-fi audio track 58

I

- Index scan 59
- Index search 59

L

- Language selection 20, 23
- LP mode 36

M

- Manual fine tuning 56
- Monaural 57
- Monitoring
 - during playback 58
 - during recording 57

N

- NICAM broadcasts 57
- Normal audio track 58

O

- Optional setting 63

P

- PDC (Programme Delivery Control) 47
- Playback 34
 - at various speeds 52
 - frame-by-frame 52
 - selecting the sound 58
 - slow motion 52
- Power save 62
- Preset download 22
- Presetting channels 24

R

- Recording 36
 - bilingual programmes 57
 - duration time 54
 - saving 38
 - stereo programmes 57
 - timer setting 49
 - using the Dial Timer 40
 - using the VIDEOPlus+ system 45
 - what you are watching on the TV 39
 - while watching another programme 37
- RF channel 20

S

- Safety tab 38
- Scart connection 17
- Searching
 - at various speeds 52
 - using the index function 59
- Smart trilogic 61
- SMARTLINK
 - NexTVView Download 18
 - One Touch Menu 18
 - One Touch Play 18, 35
 - One Touch Timer 18
 - TV Direct Rec 18, 39
- SP mode 36
- Stereo 57

T

- Timer setting 49
 - cancelling 55
 - changing 55
 - checking 55
 - daily/weekly recording 47, 50
 - using the Dial Timer 40
 - using the VIDEOPlus+ system 45

V

- VIDEOPLUS
 - recording 45

W

- Wide screen format 63

Quick Start Guide

1 Connecting the VCR

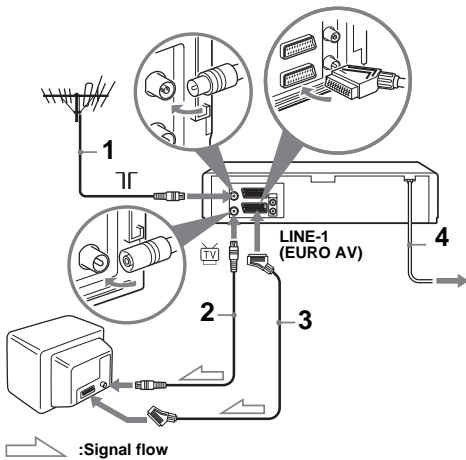

- 1 ... Connect the aerial to Γ of the VCR.
- 2 ... Connect TV and the aerial input of your TV using the supplied aerial cable.
- 3 ... For better picture and sound, connect LINE-1 (EURO AV) to your TV using a Scart cable if your TV has a Scart (EURO-AV) connector.

2 Using the Auto Set Up function

- 1 ... Turn on your TV and set it to the video channel.

If your TV does not have a Scart (EURO-AV) connector, tune the TV to channel 21 (the initial RF channel of this VCR). Refer to your TV's manual for TV tuning instructions. If the picture does not appear clearly, see "To change the RF channel."

- 2 ... Connect the mains lead to the mains.
- 3 ... Press OK.

When all of the receivable channels are preset, the menu disappears from the TV screen. You can rearrange the programme position in any order (see "Changing/disabling programme positions").

3 Setting the clock

- 1 ... Press MENU, then press $\uparrow/\downarrow/\leftarrow/\rightarrow$ to highlight CLOCK SET and press OK.
- 2 ... Press \uparrow/\downarrow to set the hour, then press \rightarrow .
- 3 ... Press \uparrow/\downarrow to set the minutes. Set the day, month, and year in sequence by pressing \rightarrow to select the item to be set, and press \uparrow/\downarrow to select the digits, then press OK.
- 4 ... Press MENU.

Now you can operate your VCR.